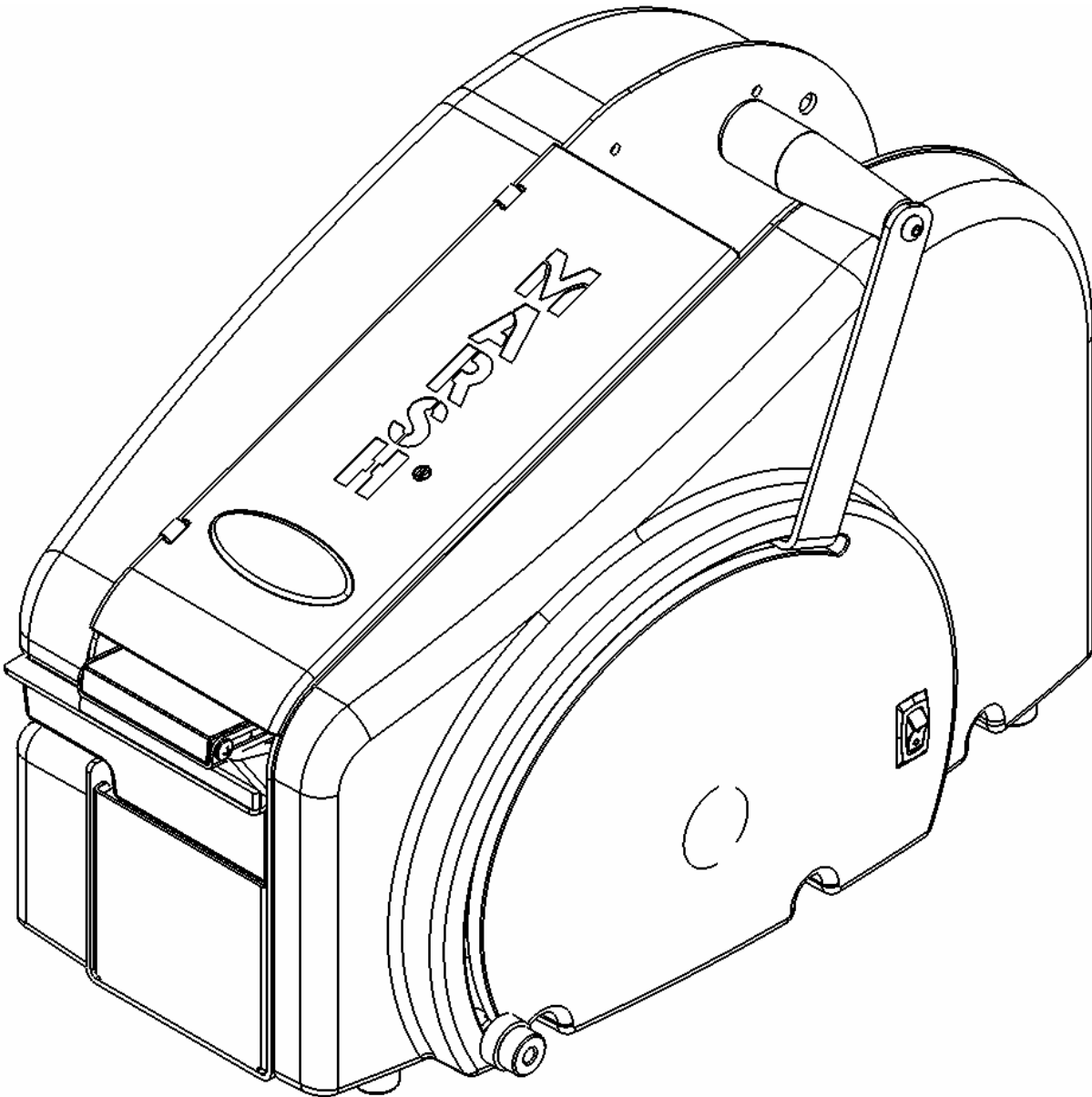


# MARSH®

Marsh Shipping Supply Co. LLC

Marsh TD2100 Manual Taper  
Technical Manual



*A wall-socket must be close to the product and readily accessible.*

*The overall system is protected against overload by the branch circuit protection in accordance with the current edition of the NEC or CEC*

## Table of Contents

4	<b>Introduction</b>
5	<b>Specifications</b>
6	<b>Setup Instructions</b>
9	<b>Operating Instructions</b>
9	<b>Maintenance</b>
12	<b>Troubleshooting</b>
12	The machine will not feed tape.
13	The ON/OFF switch is not illuminated.
14	The tape slips at the feed wheel.
14	The cutter doesn't cut the tape.
14	The handle will not or is difficult to pull forward.
15	The tape is jamming or tearing.
15	The tape is cut, but the cutter blades don't return to neutral position.
15	The tape is not the correct length.
16	The tape doesn't stick to the carton.
16	The tape slips on the carton.
17	The heater doesn't heat.
18	<b>Repair</b>
19	Removing the Handle
19	Attaching the Handle
20	Removing the Right Side Cover
20	Attaching the Right Side Cover
22	Removing the Left Side Cover
22	Attaching the Left Side Cover
24	Removing the Cutter Return Spring
24	Attaching the Cutter Return Spring
26	Removing the Pinch Roller
26	Attaching the Pinch Roller
29	Removing the Weighted Brush Cover
29	Attaching the Weighted Brush Cover
31	Removing the Tape Channel Plate
31	Attaching the Tape Channel Plate
33	Removing the Tape Basket/Motor Cover
33	Attaching the Tape Basket/Motor Cover
35	Removing the Water Tank Holder
35	Attaching the Water Tank Holder
37	Removing the Cutter Arms
37	Attaching the Cutter Arms

- 39 Removing the Movable Cutter Assembly
- 39 Attaching the Movable Cutter Assembly
- 41 Removing the Idler Gear
- 41 Attaching the Idler Gear
- 42 Removing the Drive Gear with Springs and Clutch Assembly
- 42 Attaching the Drive Gear with Springs and Clutch Assembly
- 42 Separating the Drive Gear with Springs and Clutch Assembly
- 44 Removing the Gearbox/Motor Mount
- 44 Attaching the Gearbox/Motor Mount
- 46 Replacing the Movable Cutter Blade
- 47 Replacing the Brush
- 48 Replacing the Thermostat Assembly
- 49 Replacing the Front Cover
- 49 Replacing the Top Roller
- 51 Replacing the Free Spin Roller Assembly
- 51 Replacing the Ramp
- 53 Replacing the Tape Guide Assembly
- 53 Replacing the Fixed Blade
- 55 Replacing the Feed Wheel
- 57 Replacing the Handle Shaft
- 59 **Parts List**
- 66 **Addendum**
  - 67 Removing the Weighted Brush Cover
  - 67 Attaching the Weighted Brush Cover
  - 68 Properly Repositioning the Fixed Blade Holder
  - 70 Correctly Routing Tape and Pressure Plate

## Introduction

*Congratulations on the purchase of your new **MARSH TD2100** gummed tape dispenser from MARSH SHIPPING SUPPLY CO., LLC. We are confident you will be very pleased with the operation and performance of this durable, quality built machine for many years to come.*

*The TD2100 Manual Taper Technical Manual provides the necessary information about the operation, maintenance, and repair of your new tape dispenser. However, Marsh does have a policy of continual product improvement. So, Marsh reserves the right to modify the information contained within the manual without prior notice.*

*The setup section was designed to simplify the setup of the machine and to allow you to get the machine up and running so that it can do what it is supposed to do... dispense gummed tape quietly, quickly, and accurately.*

*The operating section provides information on the operation of the machine.*

*The maintenance section provides information about required care and maintenance of the machines and further adjustments if required for your particular use.*

*This technical manual provides a troubleshooting section to help you with possible operating problems and corrective actions. Should you require replacement parts, please refer to the provided parts list.*

*Should you need assistance, or if you would like to obtain information about any Marsh product, contact your Marsh distributor or Marsh Shipping Supply Company, LLC at:*

### **Marsh Shipping Supply Company, LLC**

*Address: 926 McDonough Lake Road  
Collinsville, IL 62234 USA*

*Telephone: (618)-343-1006  
Fax: (618)-343-1016  
E-mail: customerservice@msscllc.com  
Website: www.msscllc.com*

## Specifications

**Net and Shipping Weight:** 23 pounds (10.4 kg); 29 pounds (13.2 kg)

**Water Bottle Capacity:** 70 ounces (2070 ml)

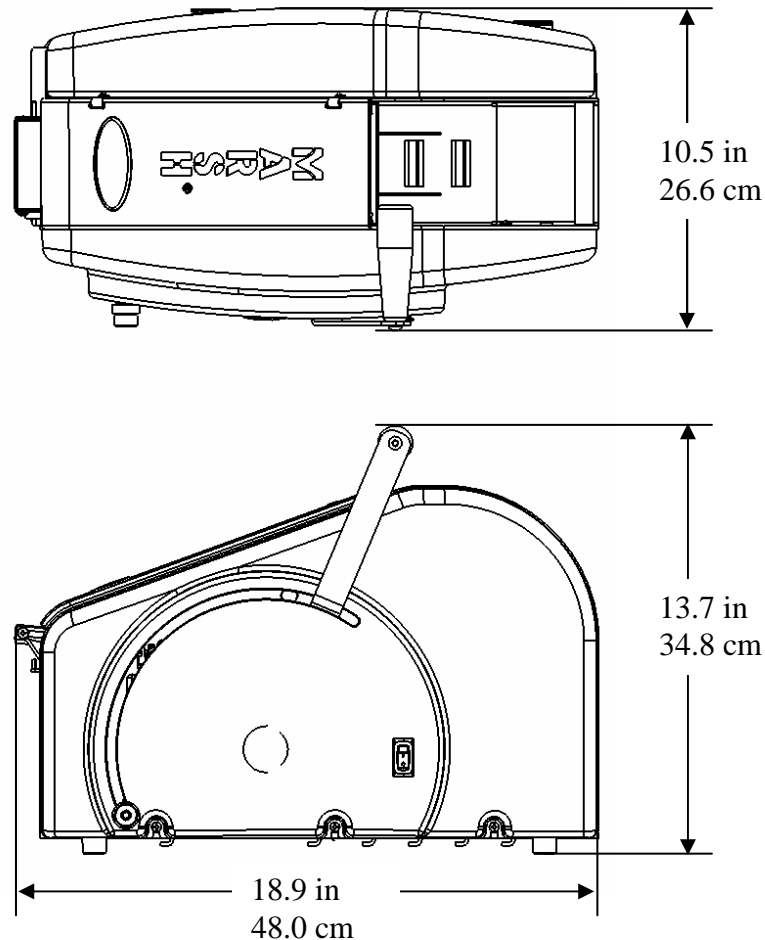
**Tape:** Dry gummed tape – paper or reinforced – between 1 to 3 inches (25.4 to 76.2 mm) wide, up to 1000 feet (304.8 m) long and 9 inches (228.6 mm) max roll diameter

**For Units with Heater:**

**Electrical Requirements:** 115 volts AC or 220 volts AC  
50/60 Hz  
4 amps at 115 volts  
2 amps at 220 volts

**Power Cord Length:** 7 feet (2.3 m)

**Dimensions:**



**Figure 1 – Tape Machine Dimensions**

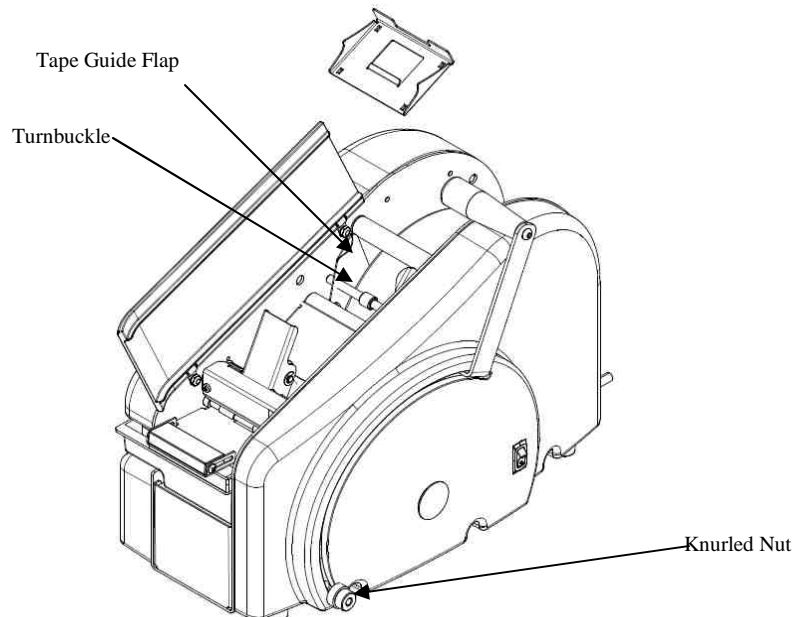
## Setup Instructions

### Loading Tape – refer to Figures 2 & 3

1. Open the top cover of the machine.
2. Adjust the tape guides, with the tape guide turnbuckle, wide enough to get the tape between them.
3. Place the roll of tape into the machine.
4. Adjust the tape guides, with the tape guides turnbuckle, to hold the tape in the middle of the machine with a 1/8” clearance on both sides.
5. Remove the pressure plate from the machine.
6. Feed the tape, gummed side down, over the top roller, under the tape guide flaps, and then under the pinch roller, see Figure 3.

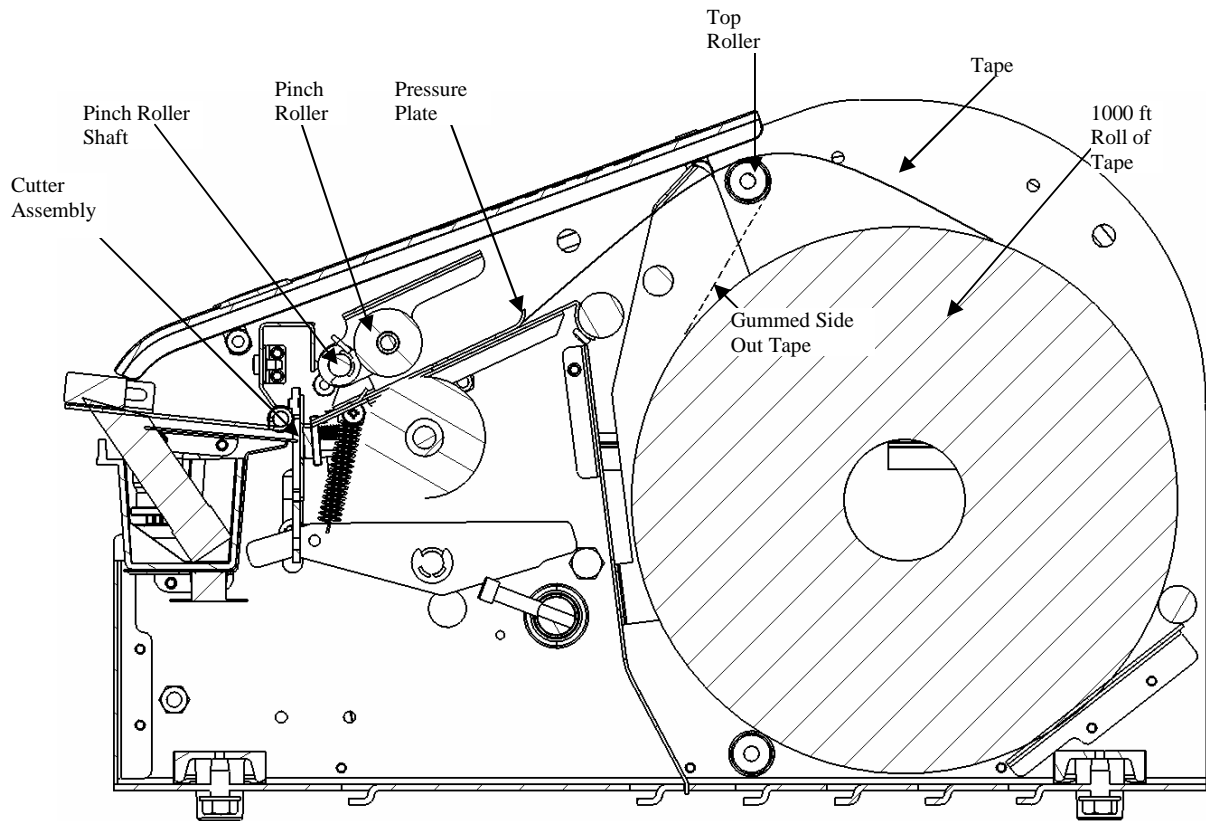
*NOTE: For gummed side out tape (typically used in Europe), load the tape roll opposite as shown and route the gummed side over the top roller.*

7. Place the pressure plate over the tape and release the pinch roller.
8. Close the top cover.

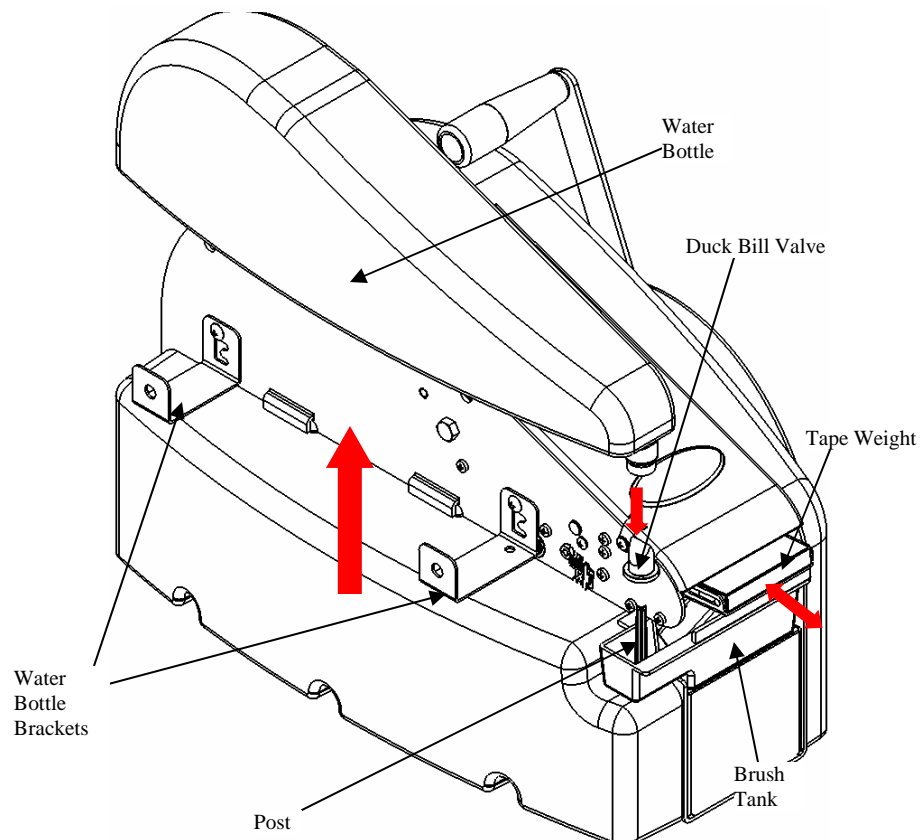


**Figure 2 – Loading Tape**

**Figure 3 – Tape Routing**

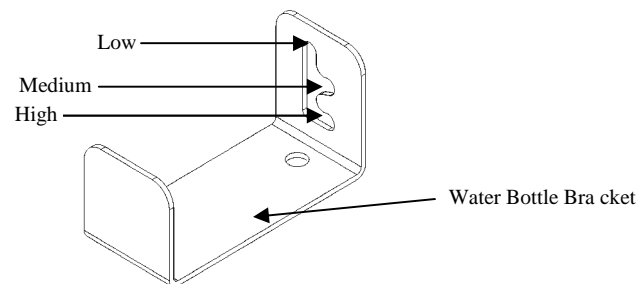


**Figure 4 – Filling the Water Bottle, Adjusting the Brush Tank Water Level, Adjusting the Tape Weight**



### Filling the Water Bottle – Figure 4

1. Remove the water bottle from the machine.
2. Remove the duckbill valve from the water bottle.
3. Fill the water bottle with water.
4. Place the duckbill valve back into the water bottle.
5. Place the water bottle back onto the machine; verify that the post in the brush tank is inserted through the duckbill valve.



**Figure 5 – Adjustable Water Level Positions**

### Adjusting the Brush Tank Water Level – refer to Figures 4 and 5

1. Loosen the retaining screws on the water bottle brackets.
2. Move the water bottle brackets to the desired position to obtain the desired water level in the brush tank. Light weight tapes would typically be set at the low position (Figure 5).
3. Both brackets should be at the same position.
4. Tighten the retaining screws on the water bottle brackets.

### Adjusting the Tape Weight – Figure 4

1. Loosen the retaining screw.
2. Slide the tape weight forward for greater pressure. This will apply more water to the tape, and is typically used on heavy weight tapes.
3. Slide the tape weight back for less pressure. This will apply less water to the tape, and is typically used on lighter weight tapes.
4. Tighten the retaining screw.



## Operating Instructions

Once the machine has been properly setup for use, pull the operating handle to the desired length that is on the scale and release the handle, when the handle returns to the resting position the tape will be cut. The mechanical stop is provided on the side of the machine (Figure 2) to be used if a known length will be used repeatedly. The mechanical stop can be moved to the desired position by loosening the knurled nut a half of a turn and sliding up or down the slot in the machine and retightening.

***Caution: The knurled nut should never be removed.***

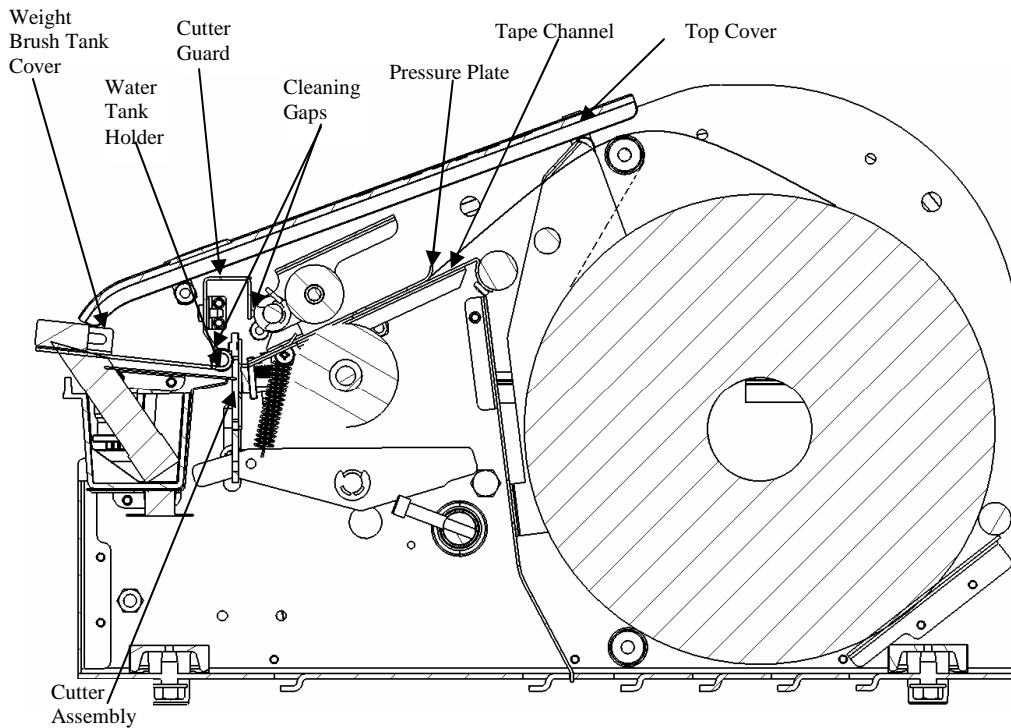
## Maintenance

The Marsh TD2100 requires very little maintenance, but it is important to regularly clean the brush, brush tank, cutter mechanism, and remove debris from the tape path.

**CAUTION: Before beginning maintenance or adjustments be sure the tape machine is turned off and unplugged.**

### **Cleaning Water Feed System**

1. Turn the power switch to the OFF position and unplug the power cord.
2. Clean the brush by soaking it in warm soapy water and then rinse.
3. Clean the brush tank by rinsing it with warm water.
4. Rinse out the water bottle and duckbill valve with warm water.



**Figure 5 – Cleaning the Cutter Assembly, Cleaning the Tape Path**

### **Cleaning the Cutter Assembly – Figure 5**

1. Turn the power switch to the OFF position and unplug the power cord.
2. Open top cover.
3. Remove pressure plate.
4. Remove the tape from the tape path.
5. Using minimal amount of a non-flammable lubricant (MG Chemicals Super Penetrating Lubricant [[www.mgchemicals.com](http://www.mgchemicals.com)], WD 40, or Marsh Industrial Silicon Spray are **recommended**), spray the cutter assembly behind the cutter guard, using the available gaps in front and behind the cutter guard. Allow the lubricant to dry or wipe dry.

**Cleaning the Tape Path – Figure 5**

1. Turn the power switch to the off position and unplug the power cord.
2. Open the top cover.
3. Remove pressure plate.
4. Remove tape from tape path.
5. Remove the cutter guard
6. Using compressed air remove all debris form the tape path.
7. Using a moist cloth wipe down all sheet metal parts within tape path (tape channel, pressure plate, weighted brush tank cover, and water tank holder) to remove debris and adhesive build-up.
8. Using compressed air remove any visible moisture from the tape path.
9. Replace the cutter guard
10. Referring to the tape loading section on pg. 6. Place the tape back into the tape path.
11. Place the pressure plate back in the machine.
12. Close the top cover.

## Troubleshooting

This section describes potential problems you may encounter while working with your TD2100 tape machine and outlines possible causes and solutions for these problems. To avoid problematic situations, be sure to follow the procedures in the setup and maintenance sections. **For units with a heater, be sure to turn the power OFF, and disconnect from power source before performing any repairs.** For further assistance please contact your Marsh distributor or Marsh Shipping Supply Co. LLC technical support at;

Telephone: (618) 343-1006

Fax: (618) 343-1016

Email: customerservice@mssc llc.com

### **Problem: The machine will not feed the tape.**

#### *Possible Cause:*

#### *Solution:*

- |                                       |   |
|---------------------------------------|---|
| 1. Is the path of the tape blocked?   | 1. Clear all debris from the path of the tape. Ensure clearance at: <ol style="list-style-type: none"> <li>a. the blades</li> <li>b. feed wheel</li> </ol> Refer to <b>Maintenance (p. 9)</b> .         |
| 2. Is the path of the tape dirty?     | 2. Remove the pressure plate, remove all debris from the tape with a damp cloth, and then replace the pressure plate. Refer to <b>Maintenance (p. 9)</b> .  |
| 3. Are the tape guides set correctly? | 3. Adjust the tape guide turnbuckle to ensure a 1/8" gap on each side of the tape roll.   |
| 4. Is the tape routed correctly?      | 4. Route the tape according to Fig 3 (p. 7).  |
| 5. Is the feed wheel set screw loose? | 5. Make sure the feed wheel is in the correct position, and then tighten the feed wheel set screw (refer to <b>Removing the Tape Channel Plate [p. 30]</b> to gain access to the feed wheel set screw). |

**Problem: The ON/OFF switch is not illuminated.**

*Possible Cause:*

1. Is the machine plugged in?
2. Is the switch turned to the ON position?
3. Is the switch properly connected?
4. Is the switch faulty?

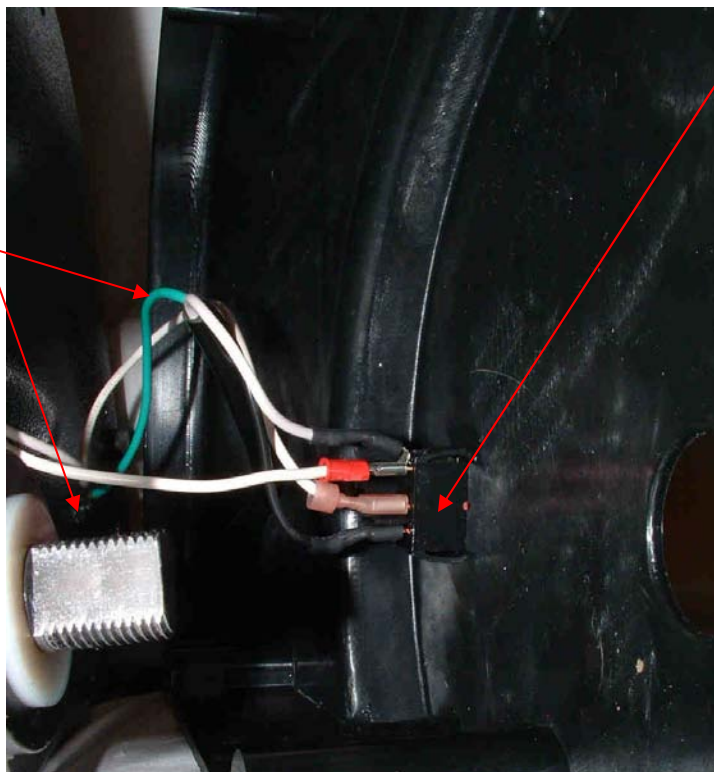
*Solution:*

1. Plug the machine into an appropriate power source.
2. Turn the power switch to ON.
3. Connect the power cord wires to the switch as shown in Fig 6.
4. Replace the power switch.

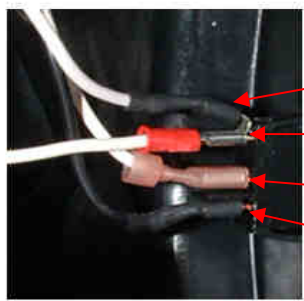
**Fig 6**

**Power Cord** -  
Connects the power supply to the switch.

**Ground Connection** -  
Green in color.  
Connects the power cord to the chassis.



**Switch** - Connects the power cord to the heater and thermostat assemblies and turns ON and OFF.



Spade terminal to power cord

Spade terminal to heater

To Thermostat

To Power Cord (**MUST** be the black cable)

**Problem: The tape slips at the feed wheel.***Possible Cause:*

1. Is the feed wheel dirty?
2. Is the feed wheel set screw loose?

*Solution:*

1. Remove any tape from the machine, and wipe the feed wheel with a damp cloth.
2. Tighten the feed wheel set screw (refer to **Removing the Tape Channel Plate [p. 30]** to gain access to the feed wheel set screw).

**Problem: The cutter doesn't cut the tape.***Possible Cause:*

1. Is the cutter clean?
2. Are the blades of the cutter dull or worn?
3. Has the fixed blade holder been knocked out of the correct position?

*Solution:*

1. Clean the cutter blades. Refer to **Maintenance (p. 9)**.
2. Replace the cutters. Refer to **Replacing the Movable Cutter Blade (p. 45)** and/or **Replacing the Fixed Blade (p. 52)**.
3. Properly position the fixed blade holder. (p. 70)

**Problem: The handle is either difficult to or won't pull forward***Possible Cause:*

1. Are the blades of the cutter dull or worn?
2. Is the feed wheel set screw loose?
3. Are the clutch bearings bad?

*Solution:*

1. Replace the cutters. Refer to **Replacing the Movable Cutter Blade (p. 45)** and/or **Replacing the Fixed Blade (p. 52)**.
2. Tighten the feed wheel set screw (refer to **Removing the Tape Channel Plate [p. 30]** to gain access to the feed wheel set screw).
3. Replace the clutch. Refer to **Replacing the Drive Gear with Spring and Clutch Assembly (p. 41)**.

**Problem: The tape is jamming or tearing.***Possible Cause:*

1. Is the pressure plate all the way to the pinch roll shaft?
2. Is the brush installed correctly?
3. Are the tape guides spaced correctly?

*Solution:*

1. Place the pressure plate all the way down to the pinch roll shaft and make sure the pressure plate lays flat. (p. 70)
2. Install the brush correctly. Refer to **Replacing the Brush (p. 46)**.
3. Adjust the tape guides to have a  $\frac{1}{8}$ " gap on each side of the tape.

**Problem: The tape is cut, but the cutter blades don't return to the neutral position***Possible Cause:*

1. Are the cutter blades clean?

*Solution:*

1. Clean the cutter blades. Refer to **Maintenance (p. 9)**.

**Problem: The tape is not the correct length.***Possible Cause:*

1. Is the tape the wrong length?

*Solution: NOTE: Accuracy  $\pm \frac{1}{2}$ "*

1. Clean the feed wheel. Check to see if the feed wheel is spinning on the feed wheel shaft. If the feed wheel is spinning on the feed wheel shaft, tighten the set screws on the feed wheel (refer to **Removing the Tape Channel Plate [p. 30]** to gain access to the feed wheel set screw).

**Problem: The tape doesn't stick to the carton.***Possible Cause:*

1. Is the water bottle full?
2. Is the brush clean?
3. Are the brush bristles worn?
4. Is there the correct amount of pressure on the tape?
5. Are the cartons dirty?
6. Is the water being heated?  
(Only if you have a heated model of the TD2100 HT)

*Solution:*

1. Fill the water bottle.
2. Clean the brush.
3. If the bristles do not extend above the top of the brush tank, the brush needs to be replaced.
4. Adjust the tape weight accordingly.
5. The cartons need to be free of dust and dirt for proper adhesion.
6. See the trouble shooting section for **The heater doesn't heat (p. 17)**.

**Problem: The tape slips on the carton.***Possible Cause:*

1. Is the tape too wet?
2. Are the cartons dirty?

*Solution:*

1. Adjust the water level and/or the tape weight.
2. The cartons need to be free of dust and dirt for proper adhesion.



**Problem: The heater doesn't heat.***Possible Cause:*

1. Is the machine plugged in?
2. Is the machine turned on?
3. Is the thermostat securely attached?
4. Is the heater connected properly?
5. Are the wires connected to the heater?
6. Is the thermostat faulty?
7. Is the heater faulty?

*Solution:*

1. Plug the machine into an appropriate power source.
2. Turn the power switch to ON.
3. Tighten the screws holding the thermostat on (refer to **Replacing the Thermostat Assembly** and Fig 30 [p. 46]).
4. Connect all wires as shown in Fig 6 (p. 13).
5. You need to replace the heater assembly. Refer to **Removing the Water Tank Holder (p. 34)**.
6. You may need to replace the thermostat assembly. Refer to **Replacing the Thermostat Assembly (p. 46)**.
7. You may need to replace the heater assembly. Refer to **Removing the Water Tank Holder and Attaching the Water Tank Holder (p. 34)**.

## Repair

### For any Repairs

To attempt any repairs, the foot channels should be loosened (Fig 7). This allows the chassis to “relax.” If the foot channels are not loosened, taking apart the machine will be difficult and may not reassemble together correctly.

### For any Repairs involving Aluminum Sheet Metal

When attempting any repairs involving steel sheet metal pieces, do not over tighten the screws. The screws are to keep the part in place not to provide structural support. The screws should be **snug, not tight**.

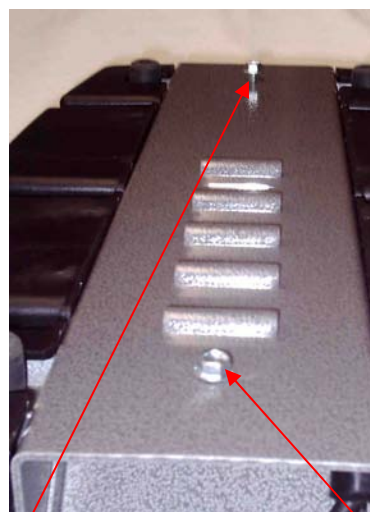
### Tools for Repair

When attempting any repairs to the TD 2100, certain tools make the disassembly and reassembly of the TD 2100 easier (Fig 13). Below is a list of the tools that are recommended for the disassembly and assembly of the TD 2100.

- $\frac{3}{8}$ " flat head screw driver
- #2 4" Phillips head screw driver
- #2 8" Phillips head screw driver
- Needle nose pliers
- Vice grips
- $\frac{5}{16}$ " wrench or socket
- $\frac{3}{8}$ " wrench or socket
- $\frac{7}{16}$ " wrench or socket
- $\frac{1}{2}$ " wrench or socket
- $\frac{15}{16}$ " socket
- $\frac{3}{32}$ " long hex key
- $\frac{5}{64}$ " hex key
- $\frac{1}{8}$ " hex key
- $\frac{3}{16}$ " hex key
- $\frac{1}{4}$ " hex key



**Fig 7**



Loosen both screws on the bottom of the chassis.

**Fig 8**

## Removing the Handle

To remove the handle, see Fig 9 and follow the steps below.

1. Remove the handle hole plug.
2. Remove the 15/16 inch nut.
3. Slide the handle OFF of the handle shaft.
4. Rotate the handle forward to about the 12 inch mark on the right side cover and pull the handle gently from the machine.

The handle is now removed. At this point a handle may be installed.

## Attaching the Handle

To attach the handle, see Fig 9 and follow the steps below.

1. Insert the handle into the right side cover at the 12 inch mark on the right side cover.
2. Rotate the handle so that the hole in the handle and the handle shaft line up.
3. Slide the handle onto the handle shaft.
4. Attach the 15/16 inch nut.
5. Attach the handle hole plug.

The machine is now ready to continue normal operation.

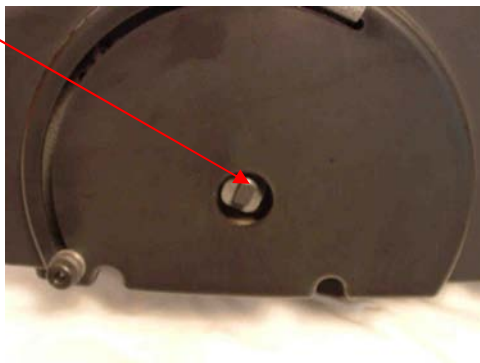
## Fig 9 Handle



2. Remove the 15/16 inch nut.



3. Slide the handle OFF of the handle shaft.



4. Rotate the handle forward to about the 12 inch mark on the right side cover and pull the handle gently from the machine.

## Removing the Right Side Cover

To remove the right side cover, see Fig 10 and follow the steps below.

1. Turn the switch to OFF and unplug the machine.
2. Remove the water bottle and duckbill valve.
3. Remove the water tank and brush.
4. Open the top cover.
5. Remove the handle hole plug.
6. Remove the 15/16 inch nut from the handle shaft.
7. Remove the three screws along the inside of the machine.
8. Remove the three screws along the outside of the machine.
9. Slide the handle to the end of the handle shaft and slowly remove the right side cover with the handle.

***CAUTION:** There are several wire connections made between the chassis and the right side cover. **Do not damage these connections.***

***NOTE:** For light maintenance, only disconnect the top wire from the inside of the right cover. Place the right side cover at the back of the machine. To reattach the right side cover from this point, refer to step 3 of **Attaching the Right Side Cover**.*

10. Remove the power wires from the ON/OFF switch, noting the color and connection configuration.

The right side cover is now completely removed from the chassis. At this point a new right side cover may be installed.

## Attaching the Right Side Cover

To attach the right side cover, see Fig 6, Fig 10, and follow the steps below.

1. Bring the right side cover close enough to attach the power wires to the switch.
2. Attach the power wires.
3. Place the handle in the slot of the right side cover and slide the handle onto the handle shaft.
4. Attach the three screws along the outside of the machine.
5. Attach the three screws along the inside of the machine.
6. Attach the 15/16 inch nut to the handle shaft.
7. Attach the handle hole plug.
8. Close the top cover.
9. Place the water tank and brush into the water tank holder.
10. Place the water bottle and duckbill valve onto the water bottle brackets with the post of the water tank into the duckbill valve.

The machine is now ready to continue normal operation.

**Fig 10 Right Side Cover**

7. Remove the three screws along the inside of the machine.

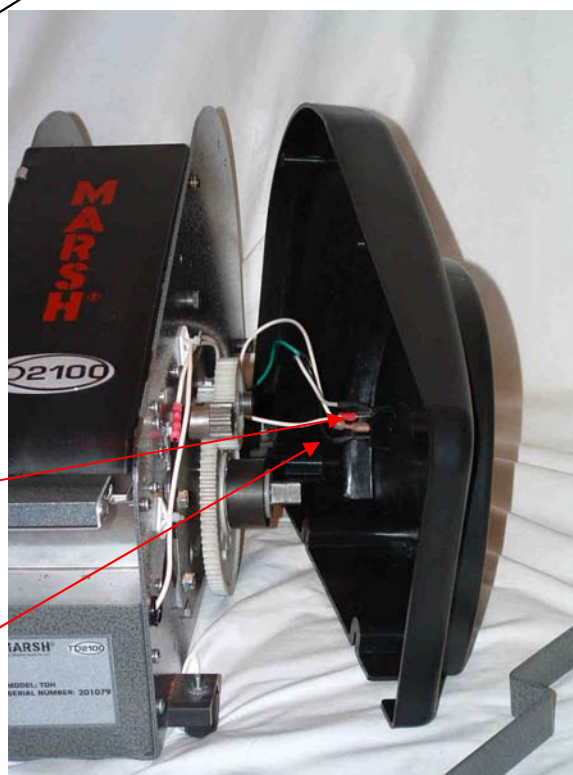


8. Remove the three screws along the outside of the machine.

9. Slide the handle to the end of the handle shaft and slowly remove the right side cover with the handle.

*NOTE: For light maintenance, only disconnect the top wire from the inside of the right cover. Place the right side cover at the back of the machine. To reattach the right side cover from this point, refer to step 3 of **Attaching the Right Side Cover**.*

10. Remove the power wires from the ON/OFF switch, noting the color and connection configuration.



## **Removing the Left Side Cover**

To remove the left side cover, see Fig 11 and follow the steps below.

1. Remove the water bottle and duckbill valve.
2. Remove water tank and brush.
3. Remove the three screws along the bottom edge of the left side cover.
4. Slide the left side cover towards the bottom of the machine, and remove the left side cover.

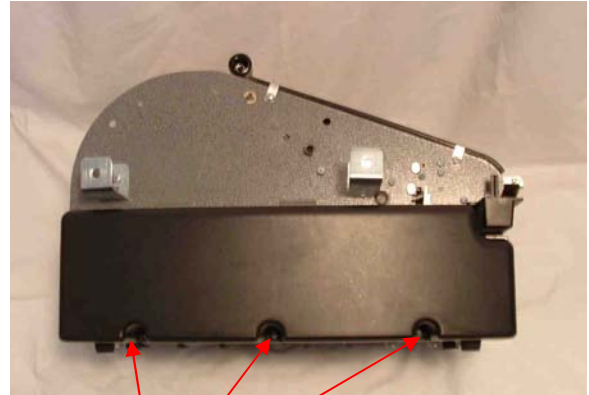
The left side cover is now removed. At this point a new left side cover may be installed.

## **Attaching the Left Side Cover**

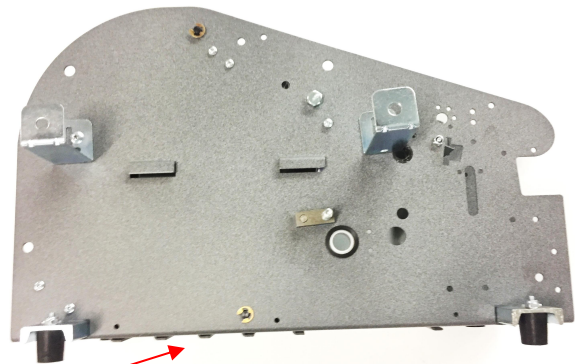
To attach the left side cover, see Fig 11 and follow the steps below.

1. Place the left side cover on the chassis aligning the tabs in the left side cover with the corresponding tabs on the chassis.
2. Slide the left side cover towards the top of the machine.
3. Screw the three screws along the bottom edge of the left side cover into the chassis.
4. Place the water tank and brush into the water tank holder.
5. Place the water bottle and duckbill valve onto the water bottle brackets with the post of the water tank into the duckbill valve.

The left side cover is now attached.

**Fig 11 Left Side Cover**

4. Remove the three screws along the bottom edge of the left side cover.



4. Slide the left side cover towards the bottom of the machine and pull the left side cover away.

## Removing the Cutter Return Spring

To remove the cutter return spring, see Fig 12 and follow the steps below.

1. Turn the switch to OFF and unplug the machine.
2. Remove the right side cover (refer to **Removing the Right Side Cover [p. 20]**).
3. Remove the left side cover (refer to **Removing the Left Side Cover [p. 22]**).
4. Remove the four screws from the front cover and remove the front cover.
5. Attach a pair of vice grips to the screw attached to the cutter return spring.
6. While holding the vice grips, remove the nut on the inside of the machine from the screw.
7. Slowly pull the screw from the chassis and release the tension from the cutter return spring.
8. Remove the cutter slide bolt from the handle shaft.

The cutter return spring is now removed. At this point a new cutter return spring may be installed.

## Attaching the Cutter Return Spring

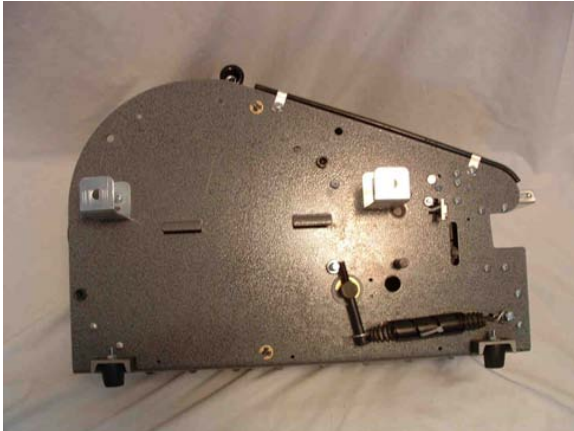
To attach the cutter return spring, see Fig 12 and follow the steps below.

1. Put the S-hook of the cutter return spring onto the cutter slide bolt then slide a washer onto the cutter slide bolt.
2. Attach the cutter slide bolt to the handle shaft.
3. Slide the end of the spring onto the screw and then attach the nut to the screw.
4. Attach a pair of vice grips to the screw, and pull the spring until the screw is in the correct hole in the chassis.
5. While holding the spring stretched with the vice grips, attach the other nut to the screw.
6. Position the front cover into place and attach four screws to the front cover.
7. Attach the left side cover (refer to **Attaching the Left Side Cover [p. 22]**).
8. Attach the right side cover (refer to **Attaching the Right Side Cover [p. 20]**).

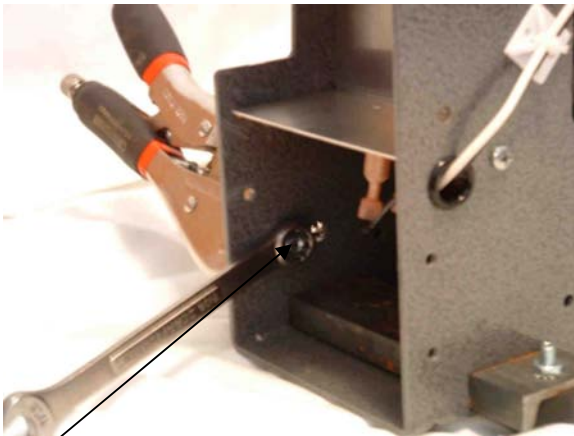
The machine is now ready to continue normal operation.



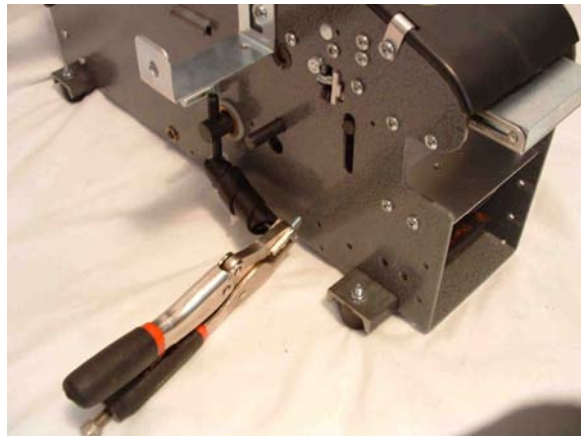
**Fig 12 Cutter Return Spring**



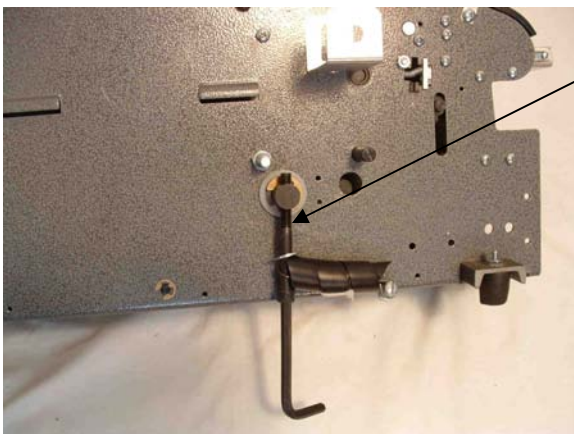
5. Attach a pair of vice grips to the screw attached to the cutter return spring.



6. While holding the vice grips, remove the nut on the inside of the machine from the screw.



7. Slowly pull the screw from the chassis and release the tension from the cutter return spring.



8. Remove the cutter slide bolt from the handle shaft.

## Removing the Pinch Roller

To remove the pinch roller, see Fig 13 and follow the steps below according to the serial number of the machine.

### For S/N 202488 (heater: 400543) and below:

1. Remove the water bottle.
2. Remove the pressure plate.
3. Facing the front of the machine, pull the pinch roller spring towards the front and to the left of the machine until the spring is no longer on the pinch roller.
4. Release the pinch roller spring gently.
5. Remove the four  $\frac{3}{8}$ " e-clips from the pinch roller shaft.

**CAUTION: Do not let the e-clips fall into the machine.**

6. With one hand holding the pinch roller and the pinch roller spring, slide the pinch roller shaft to the left until the pinch roller shaft is no longer on the chassis.

### For S/N 202489 (heater: 400544) and above:

1. Remove the water bottle.
2. Remove the pressure plate.
3. Facing the front of the machine, pull the pinch roller springs towards the front and to the left and right of the machine until the springs are no longer on the pinch roller.
4. Release the pinch roller spring gently.
5. Remove the four  $\frac{3}{8}$ " e-clips from the pinch roller shaft.

**CAUTION: Do not let the e-clips fall into the machine.**

6. With one hand holding the pinch roller and the pinch roller spring, slide the pinch roller shaft to the left until the pinch roller shaft is no longer on the chassis.

The pinch roller is now removed. At this point a new pinch roller may be installed.

## Attaching the Pinch Roller

To attach the pinch roller, see Fig 13 and follow the steps below.

1. From the left side of the machine, put the pinch roller shaft into the chassis.

*NOTE: Insert the shaft approximately  $\frac{1}{4}$  of the way into the chassis.*

2. Put the pinch roller spring on the shaft.
3. Put the pinch roller on the pinch roller shaft.
4. With the left end of the pinch roller spring on top of the screw on the left side of the machine, slide the pinch roller shaft into the right side of the chassis.
5. Attach the four  $\frac{3}{8}$ " e-clips onto the pinch roller shaft.
6. Pull the pinch roller spring toward the front and to the right of the machine until the spring is over the pinch roller.
7. Release the pinch roller spring gently.
8. Place pressure plate underneath the pinch roller.
9. Attach the water bottle.

The machine is now ready to continue normal operation.

**Fig 13 Pinch Roller, Serial Numbers 202488 (heater: 400543) and Below**

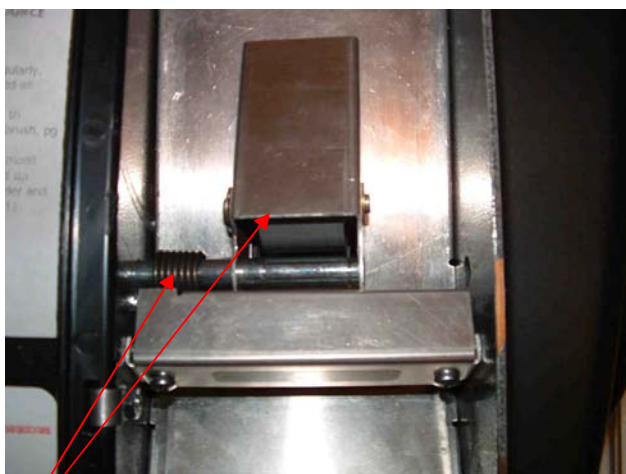


2. Remove the pressure plate.

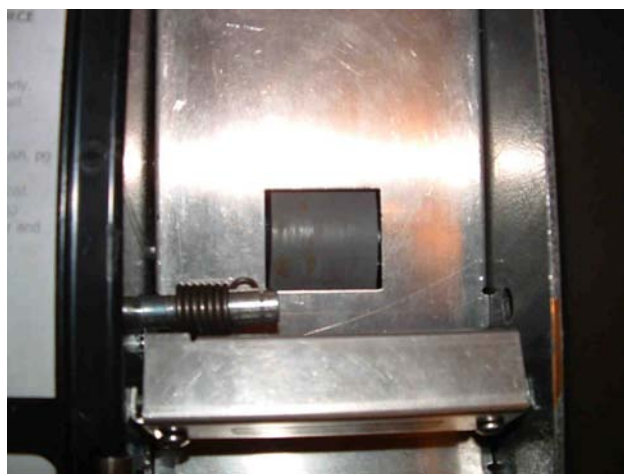


3. Facing the front of the machine, pull the pinch roller springs towards the front and to the left and right of the machine until the springs are no longer on the pinch roller.

4. Release the pinch roller spring gently.



6. With one hand holding the pinch roller and the pinch roller spring, slide the pinch roller shaft to the left until the pinch roller shaft is no longer on the chassis.

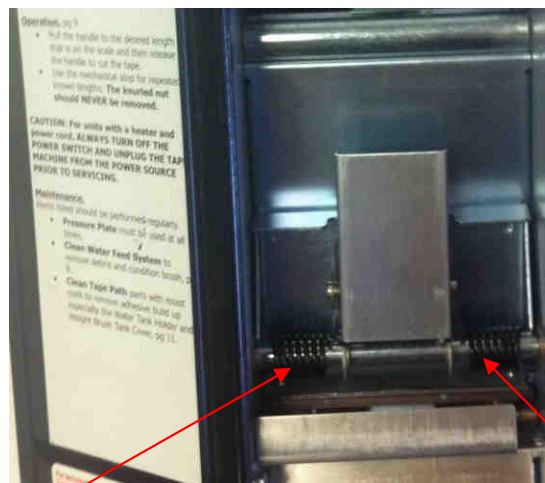


4. With the left end of the pinch roller spring on top of the screw on the left side of the machine, slide the pinch roller shaft into the right side of the chassis.

**Fig 13 Pinch Roller, Serial Numbers 202489 (heater: 400544) and Above**



2. Remove the pressure plate.

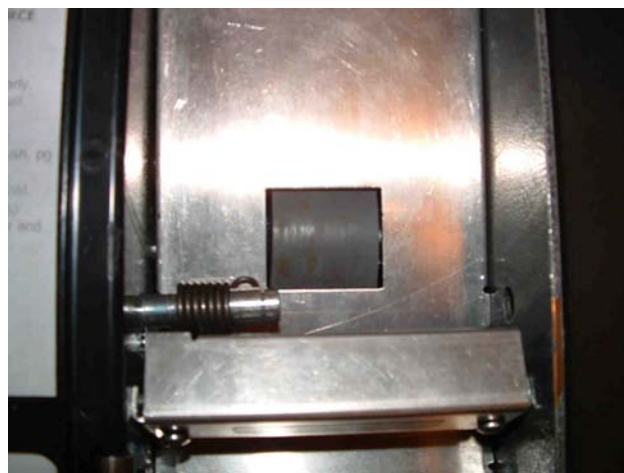


3. Facing the front of the machine, pull the pinch roller springs towards the front and to the left and right of the machine until the springs are no longer on the pinch roller.

4. Release the pinch roller spring gently.



6. With one hand holding the pinch roller and the pinch roller spring, slide the pinch roller shaft to the left until the pinch roller shaft is no longer on the chassis.



4. With the left end of the pinch roller spring on top of the screw on the left side of the machine, slide the pinch roller shaft into the right side of the chassis.

### **Removing the Weighted Brush Cover**

To remove the weighted brush cover, see Fig 14 and follow the steps below.

1. Turn the switch to OFF and unplug the machine.
2. Remove the right side cover (refer to **Removing the Right Side Cover [p. 20]**).
3. Remove the water bottle.
4. Remove the cutter guard.
5. Remove the screws from the flapper shaft.
6. Slide the flapper shaft, weighted brush cover, tape weight, and bushings from the front of the machine.
7. Remove the screw from the tape weight and remove the tape weight from the weighted brush cover.

The weighted brush cover is now removed from the machine. At this point, a new weighted brush cover or tape weight may be installed.

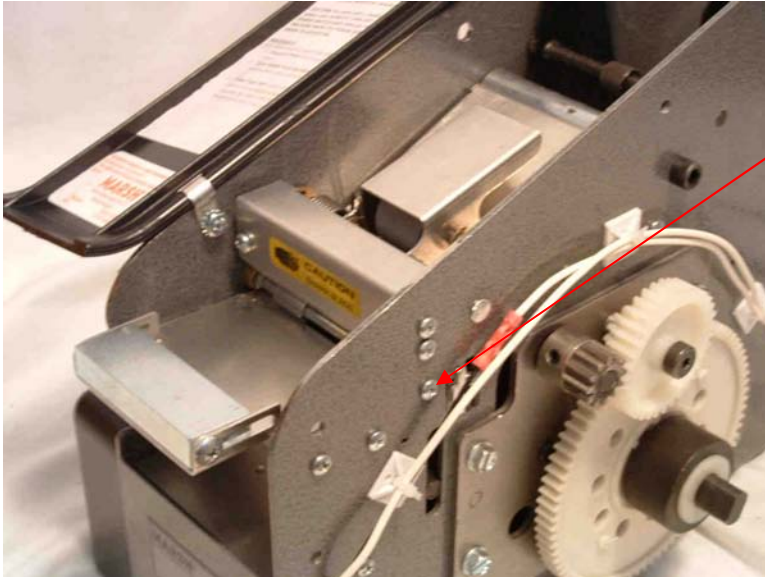
### **Attaching the Weighted Brush Cover**

To attach the weighted brush cover, see Fig 14 and follow the steps below.

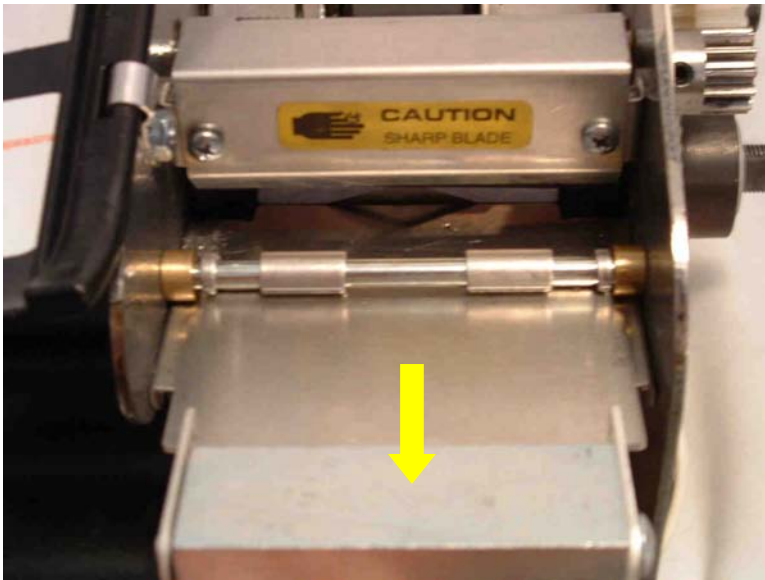
1. Position the tape weight into the new weighted brush cover and attach the screw to the weight.
2. Slide the flapper shaft into the weighted brush cover and then slide the bushings on each end of the shaft.
3. Position the weighted brush cover assembly in the chassis.
4. Attach the screws to the flapper shaft.
5. Attach the cutter guard.
6. Attach the water bottle.
7. Attach the right side cover (refer to **Attaching the Right Side Cover [p. 20]**).

The machine is now ready to continue normal operation.

**Fig 14 Weighted Brush Cover**



5. Remove the screws from the flapper shaft.



6. Slide the flapper shaft, weighted brush cover, tape weight, and bushings from the front of the machine.

## Removing the Tape Channel Plate

To remove the tape channel plate, see Fig 15 and follow the steps below.

1. Turn the switch to OFF and unplug the machine.
2. Remove the right side cover (refer to **Removing the Right Side Cover [p. 20]**).
3. Remove the pinch roller (refer to **Removing the Pinch Roller [p. 26]**).
4. Remove the weighted brush cover (refer to **Removing the Weighted Brush Cover [p. 28]**).
5. Loosen the dead roller and the coder bar screws.
6. Remove the pinch roller spring stop.
7. Remove the two screws attached to the tape channel plate.
8. Pull the tape channel plate up allowing the tape channel plate and the dead roller to rotate so the screws underneath are accessible.
9. Remove the two screws connecting the tape channel plate and the dead roller.

The tape channel plate is now removed. At this point, a new tape channel plate may be installed.

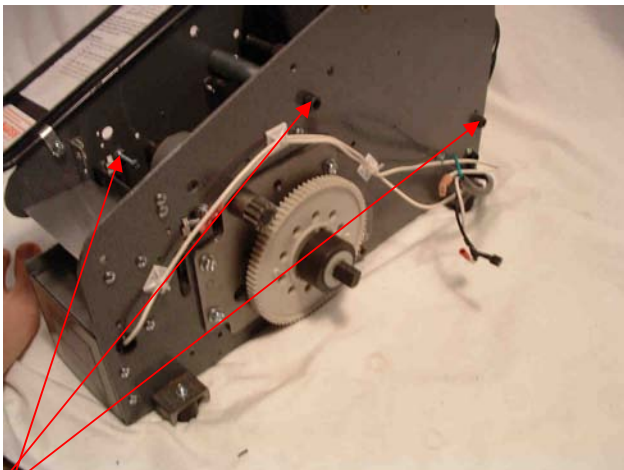
## Attaching the Tape Channel Plate

To attach the tape channel plate, see Fig 15 and follow the steps below.

1. Place the tape channel plate on the dead roller so that the screw holes on the tape channel plate and the dead roller line up.
2. Attach the tape channel plate to the dead roller with two screws.
3. Push down on the tape channel plate until the holes in the chassis line up with the holes in the tape channel plate.
4. Attach the tape channel plate to the chassis with two screws.
5. Attach the pinch roller spring stop.
6. Tighten the dead roller and coder bar screws.
7. Attach the weighted brush cover (refer to **Attaching the Weighted Brush Cover [p. 28]**).
8. Attach the pinch roller (refer to **Attaching the Pinch Roller [p. 26]**).
9. Attach the right side cover (refer to **Attaching the Right Side Cover [p. 20]**).

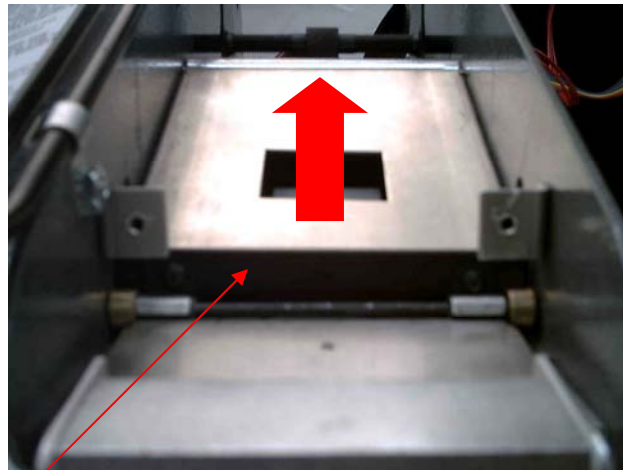
The machine is now ready to continue normal operation.

**Fig 15 Tape Channel Plate**



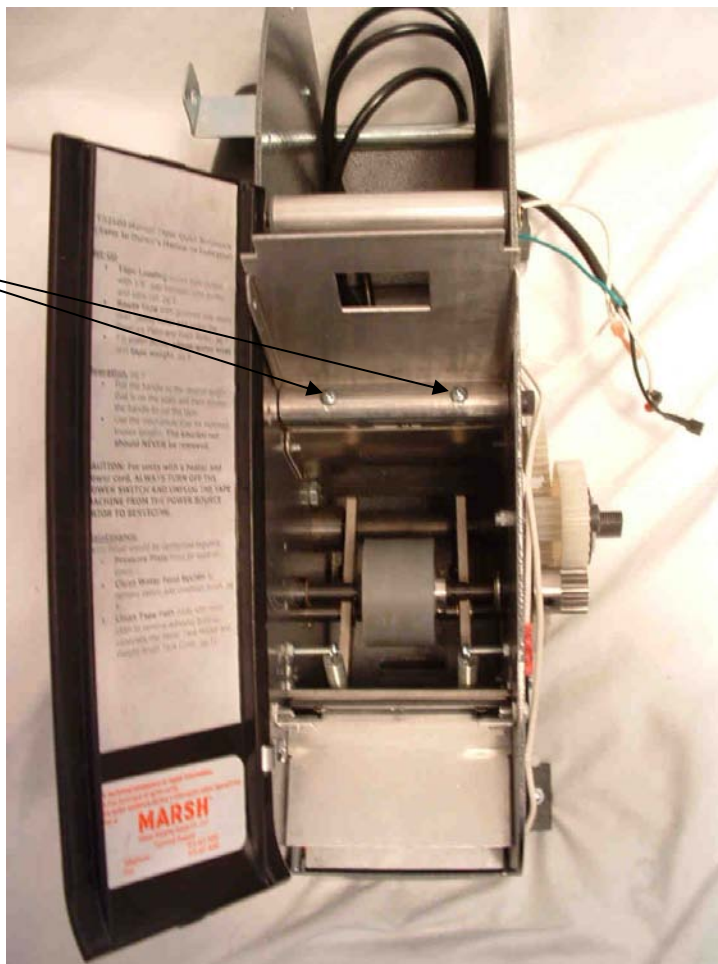
5. Loosen the dead roller and the coder bar screws.

6. Remove the pinch roller spring stop.



8. Pull up on the tape channel plate so that the tape channel plate and the dead roller rotate so that the screws underneath are accessible.

9. Remove the two screws connecting the tape channel plate and the dead roller.





## Removing the Tape Basket/Motor Cover

To remove the tape basket/motor cover, see Fig 16 and follow the steps below.

1. Turn the switch to OFF and unplug the machine.
2. Remove the right side cover (refer to **Removing the Right Side Cover [p. 20]**).
3. Remove the left side cover (refer to **Removing the Left Side Cover [p. 22]**).
4. Remove the pinch roller (refer to **Removing the Pinch Roller [p. 26]**).
5. Remove the weighted brush cover (refer to **Removing the Weighted Brush Cover [p. 28]**).
6. Remove the tape channel plate (refer to **Removing the Tape Channel Plate [p. 30]**).
7. Remove the two screws holding the tape basket/motor cover.
8. Remove the tape basket/motor cover by lifting straight up parallel with the angle that the tape basket/motor cover makes.

The large tape basket/motor cover is now removed. At this point, a new tape basket/motor cover may be installed.

## Attaching the Tape Basket/Motor Cover

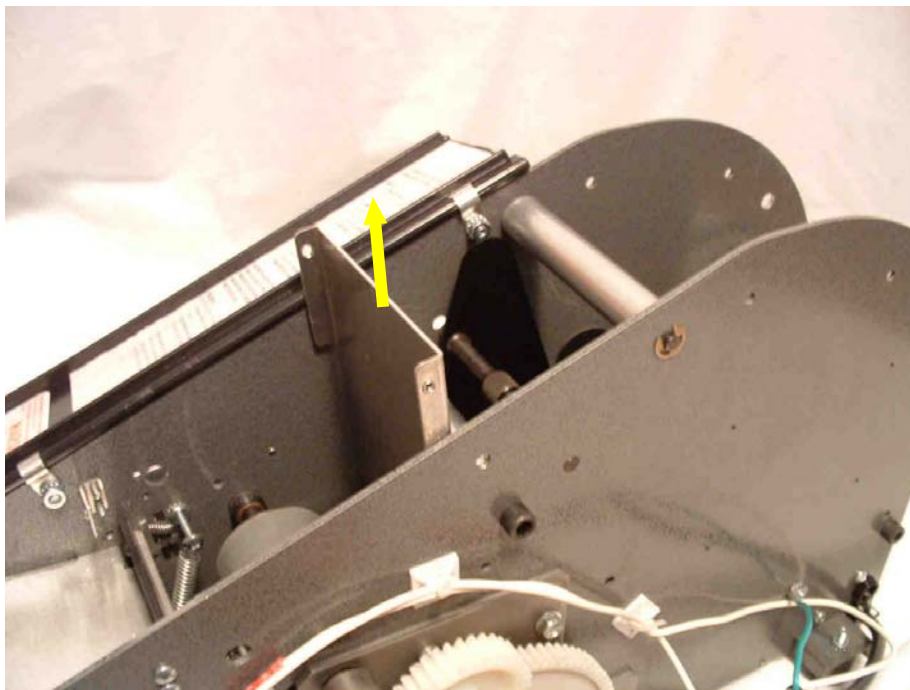
To attach the tape basket/motor cover, see Fig 16 and follow the steps below.

1. Insert the tape basket/motor cover into the machine going straight into the center and through the top of the machine.
2. Attach the tape basket/motor cover with two screws.
3. Attach the tape channel plate (refer to **Attaching the Tape Channel Plate [p. 30]**).
4. Attach the weighted brush cover (refer to **Attaching the Weighted Brush Cover [p. 28]**).
5. Attach the pinch roller (refer to **Attaching the Pinch Roller [p. 26]**).
6. Attach the left side cover (refer to **Attaching the Left Side Cover [p. 22]**).
7. Attach the right side cover (refer to **Attaching the Right Side Cover [p. 20]**).

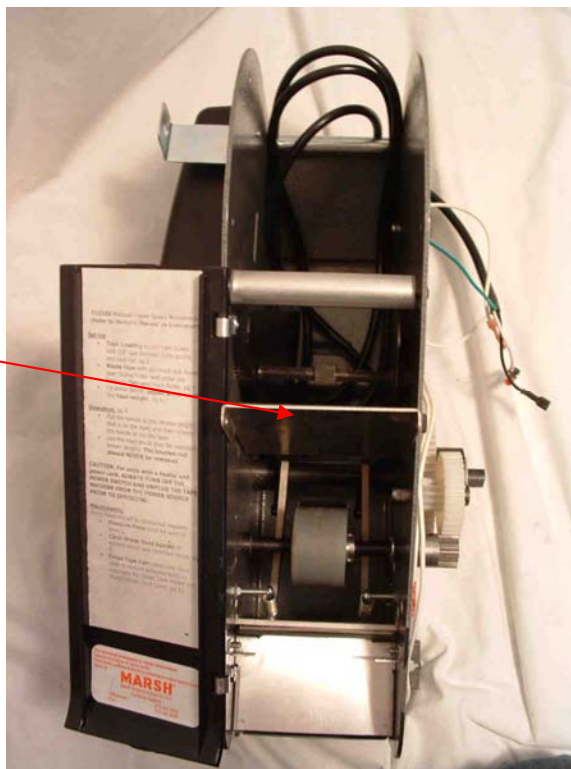
The machine is now ready to continue normal operation.

**Fig 16 Tape Basket/Motor Cover**

8. Remove the tape basket/motor cover by lifting straight up parallel with the angle that the tape basket/motor cover makes.



1. Insert the tape basket/motor cover into the machine going straight through the top and middle of the machine.



## Removing the Water Tank Holder

To remove the water tank holder, see Fig 17 and follow the steps below.

1. Turn the switch to OFF and unplug the machine.
2. Remove the right side cover (refer to **Removing the Right Side Cover [p. 20]**).
3. Remove the left side cover (refer to **Removing the Left Side Cover [p. 22]**).
4. Loosen the screws in the coder bar and dead roller.
5. Remove the four screws from the front cover.
6. Remove the front cover.
7. Remove the seven screws from the water tank holder.
8. Remove the water tank holder.

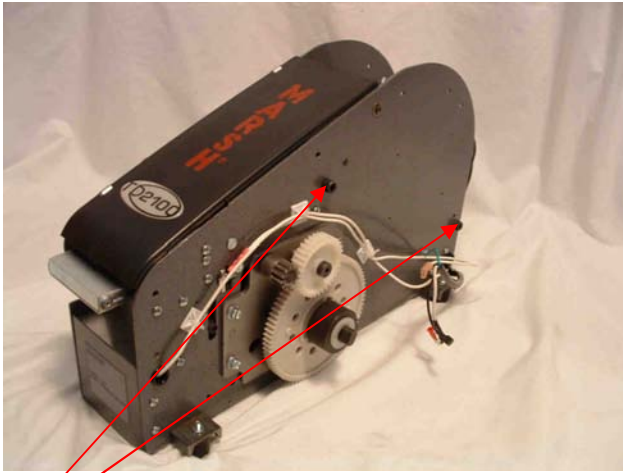
The water tank holder is now removed. At this point, a new water tank holder may be installed.

## Attaching the Water Tank Holder

To attach the water tank holder, see Fig 17 and follow the steps below.

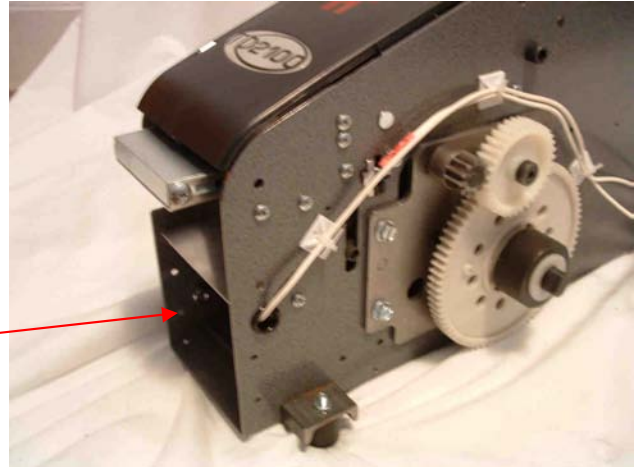
1. With one hand pushing the chassis slightly apart, position the water tank holder.
2. Loosely attach the water tank holder with the seven screws.
3. With one hand pushing the chassis slightly apart, position the front cover.
4. Attach the screws to the front cover.
5. Tighten the screws in the coder bar, dead roller, and water tank holder. Attach the left side cover (refer to **Attaching the Left Side Cover [p. 22]**).
6. Attach the right side cover (refer to **Attaching the Right Side Cover [p. 20]**).

The machine is now ready to continue normal operation.

**Fig 17 Water Tank Holder**

4. Loosen the screws in the coder bar and dead roller.

6. Remove the front cover.



8. Remove the water tank holder.

## Removing the Cutter Arms

To replace the movable cutter assembly, see Fig 18 and follow the steps below.

1. Turn the switch to OFF and unplug the machine.
2. Remove the right side **cover (refer to Removing the Right Side Cover [p. 20])**.
3. Remove the left side cover (refer to **Removing the Left Side Cover [p. 22]**).
4. Remove the pinch roller (refer to **Removing the Pinch Roller [p. 26]**).
5. Remove the weighted brush cover (refer to **Removing the Weighted Brush Cover [p. 28]**).
6. Remove the tape channel plate (refer to **Removing the Tape Channel Plate [p. 30]**).
7. Remove the water tank holder (refer to **Removing the Water Tank Holder [p. 34]**).
8. Remove the cutter arm springs from the screws they are resting upon.
9. Remove the e-clips from the cutter arm shaft.
10. Remove the cutter arm shaft from the chassis.
11. Remove the cutter arms.

The cutter arms are now removed from the machine. At this point new cutter arms may be installed.

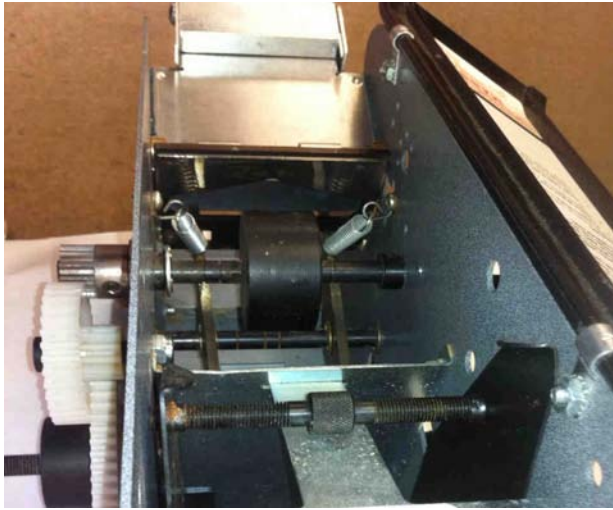
## Attaching the Cutter Arms

To replace the movable cutter assembly, see Fig 18 and follow the steps below.

1. Insert the cutter arms into the slots in the movable cutter assembly.
2. Insert the cutter arm shaft into the chassis and the cutter arms.
3. Attach the e-clips to the cutter arm shaft.
4. Attach the cutter arm springs to the screws.
5. Attach the water tank holder (refer to **Attaching the Water Tank Holder [p. 34]**).
6. Attach the tape channel plate (refer to **Attaching the Tape Channel Plate [p. 30]**).
7. Attach the weighted brush cover (refer to **Attaching the Weighted Brush Cover [p. 28]**).
8. Attach the pinch roller (refer to **Attaching the Pinch Roller [p. 26]**).
9. Attach the left side cover (refer to **Attaching the Left Side Cover [p. 22]**).
10. Attach the right side cover (refer to **Attaching the Right Side Cover [p. 20]**).

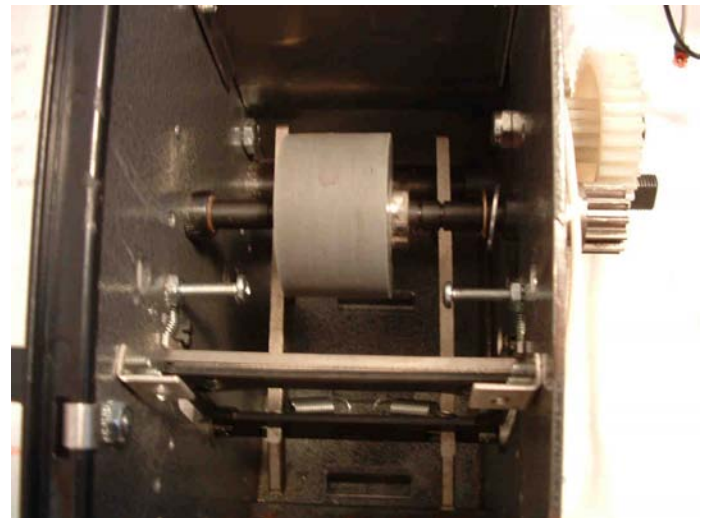
The machine is now ready to continue normal operation.

**Fig 18 Cutter Arms**



8. Remove the cutter arm springs from the screws they are resting on.

10. Remove the cutter arm shaft from the chassis.



11. Remove the cutter arms.

## Removing the Movable Cutter Assembly

To replace the movable cutter assembly, see Fig 19 and follow the steps below.

1. Turn the switch to OFF and unplug the machine.
2. **Removing the Right Side Cover [p. 20)].**
3. Remove the left side cover (refer to **Removing the Left Side Cover [p. 22)].**
4. Remove the pinch roller (refer to **Removing the Pinch Roller [p. 26)].**
5. Remove the weighted brush cover (refer to **Removing the Weighted Brush Cover [p. 28)].**
6. Remove the tape channel plate (refer to **Removing the Tape Channel Plate [p. 30)].**
7. Remove the water tank holder (refer to **Removing the Water Tank Holder [p. 34)].**
8. Remove the cutter arms (refer to **Removing the Cutter Arms [p. 36)].**
9. Rotate the movable cutter assembly towards the front of the machine.
10. Twist the movable cutter assembly and remove from the machine.

The movable cutter assembly is now removed from the machine. At this point a new movable cutter assembly may be installed.

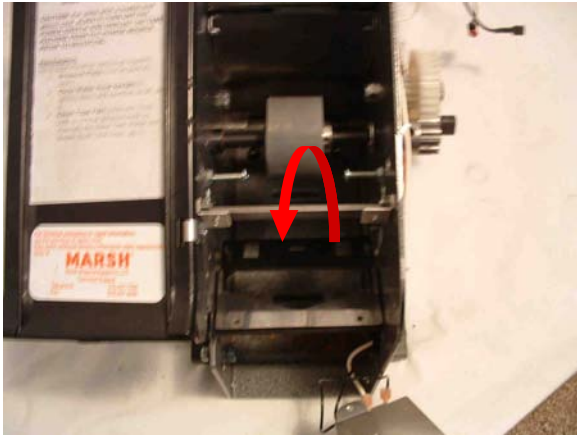
## Attaching the Movable Cutter Assembly

To replace the movable cutter assembly, see Fig 19 and follow the steps below.

1. Place the movable cutter into the precut slots in the chassis at an angle.
2. Untwist the movable cutter assembly and rotate the movable cutter assembly upwards.
3. Attach the cutter arms (refer to **Attaching the Cutter Arms [p. 36)].**
4. Attach the water tank holder (refer to **Attaching the Water Tank Holder [p. 30)].**
5. Attach the tape channel plate (refer to **Attaching the Tape Channel Plate [p. 28)].**
6. Attach the weighted brush cover (refer to **Attaching the Weighted Brush Cover [p. 26)].**
7. Attach the pinch roller (refer to **Attaching the Pinch Roller [p. 26)].**
8. Attach the left side cover (refer to **Attaching the Left Side Cover [p. 22)].**
9. Attach the right side cover (refer to **Attaching the Right Side Cover [p. 20)].**

The machine is now ready to continue normal operation.

**Fig 19 Movable Cutter Assembly**



9. Rotate the movable cutter assembly towards the front of the machine.



10. Twist the movable cutter assembly and remove from the machine.



## Removing the Idler Gear

To remove the idler gear, see Fig 20 and follow the steps below.

1. Turn the switch to OFF and unplug the machine.
2. Remove the right side cover (refer to **Removing the Right Side Cover [p. 20]**).
3. Remove the left side cover (refer to **Removing the Left Side Cover [p. 22]**).
4. Remove the weighted brush cover (refer to **Removing the Weighted Brush Cover [p. 28]**).
5. Remove the tape channel plate (refer to **Removing the Tape Channel Plate [p. 30]**).
6. Remove the bolt from the center of the idler gear.

The idler gear is now removed. At this point, a new idler gear may be installed.

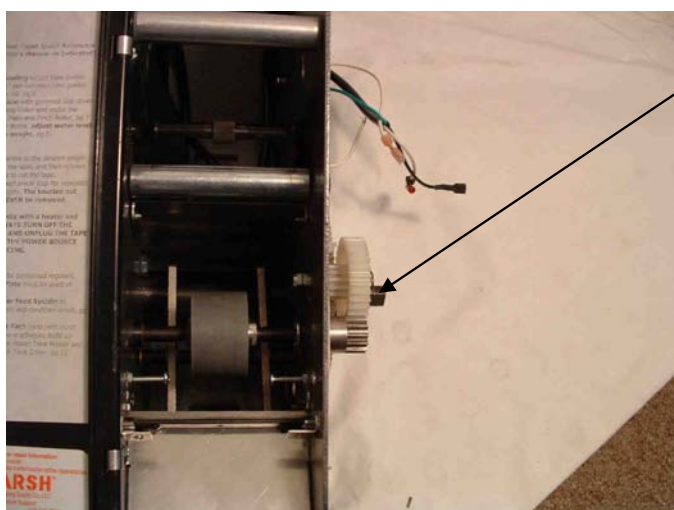
## Attaching the Idler Gear

To attach the idler gear, see Fig 20 and follow the steps below.

1. Slide the idler gear onto the bolt.
2. Attach the bolt to the chassis.
3. Attach the tape channel plate (refer to **Attaching the Tape Channel Plate [p. 30]**).
4. Attach the weighted brush cover (refer to **Attaching the Weighted Brush Cover [p. 28]**).
5. Attach the left side cover (refer to **Attaching the Left Side Cover [p. 22]**).
6. Attach the right side cover (refer to **Attaching the Right Side Cover [p. 20]**).

The machine is now ready to continue normal operation.

**Fig 20 Idler Gear**



6. Remove the bolt from the center of the idler gear.

### **Removing the Drive Gear with Springs and Clutch Assembly**

To remove the drive gear with springs and clutch assembly, see Fig 21 and follow the steps below.

1. Turn the switch to OFF and unplug the machine.
2. Remove the right side cover (refer to **Removing the Right Side Cover [p. 20]**).
3. Remove the pinch roller (refer to **Removing the Pinch Roller [p. 26]**).
4. Remove the weighted brush cover (refer to **Removing the Weighted Brush Cover [p. 28]**).
5. Remove the tape channel plate (refer to **Removing the Tape Channel Plate [p. 30]**).
6. Remove the idler gear (refer to **Removing the Idler Gear [p. 40]**).
7. Remove the drive gear and clutch assembly.

The drive gear with springs and clutch assembly are now removed.

### **Attaching the Drive Gear with Springs and Clutch Assembly**

To attach the drive gear with springs and clutch assembly, see Fig 21 and follow the steps below.

1. Slide the white washer and then the drive gear and clutch assembly onto the handle shaft.
2. Attach the idler gear (refer to **Attaching the Idler Gear [p. 40]**).
3. Attach the tape channel plate (refer to **Attaching the Tape Channel Plate [p. 30]**).
4. Attach the weighted brush cover (refer to **Attaching the Weighted Brush Cover [p. 28]**).
5. Attach the pinch roller (refer to **Attaching the Pinch Roller [p. 26]**).
6. Attach the right side cover (refer to **Attaching the Right Side Cover [p. 20]**).

The machine is now ready to continue normal operation.

### **Separating the Drive Gear with Springs and Clutch Assembly**

To separate the drive gear with springs and the clutch assembly, see Fig 21 and follow the steps below.

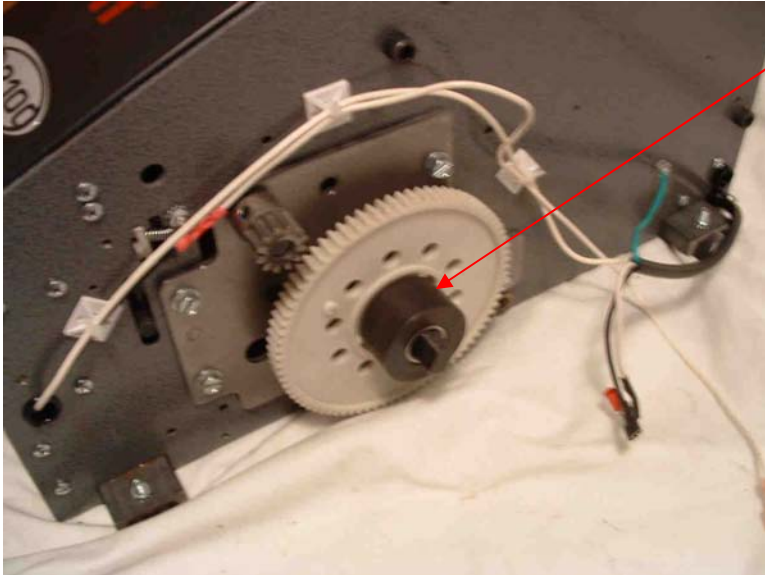
1. Remove the drive gear springs from the clutch pins.
2. Pull the drive gear with springs and the clutch assembly apart.

The drive gear with springs and the clutch assembly are now separated. At this point a new drive gear with springs and/or clutch assembly may be installed. To assemble the drive gear with springs and the clutch assembly, see Fig 21 and follow the steps below.

3. With the drive gear springs on top put the clutch pins through the holes near the center of the drive gear.
4. Attach the springs to the nearest clutch pins.

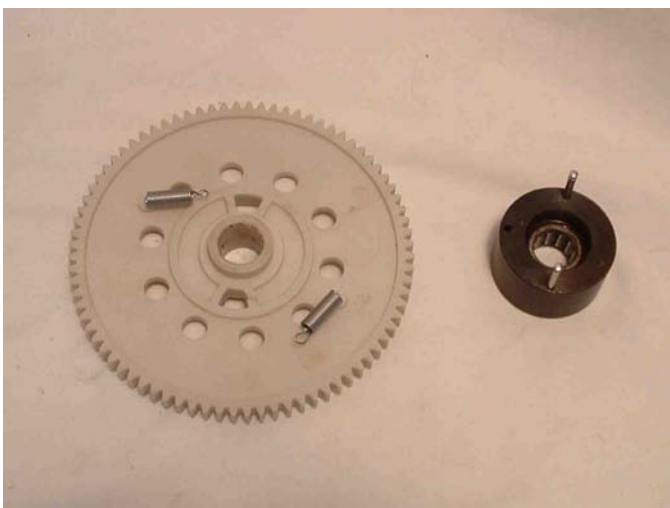
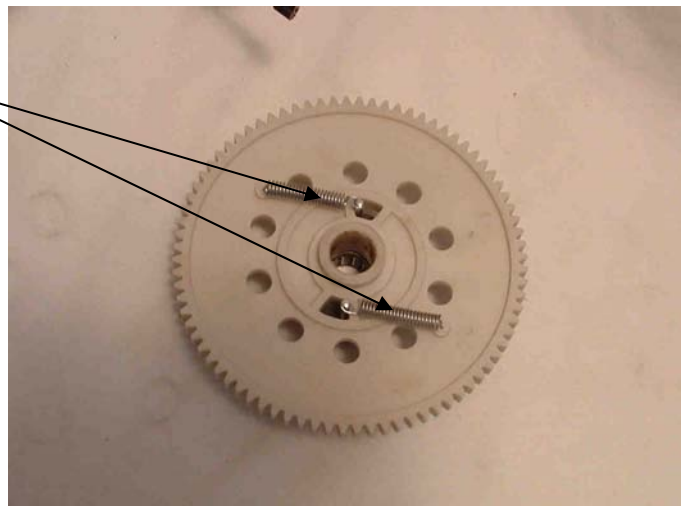
The drive gear with springs and the clutch assembly are now ready to be attached to the machine.

**Fig 21 Drive Gear with Springs and Clutch Assembly**



7. Remove the drive gear and clutch assembly.

1. Remove the drive gear springs from the clutch pins.



2. Pull the drive gear with springs and the clutch assembly apart.

## Removing the Gearbox/Motor Mount

To remove the gearbox/motor mount, see Fig 22 and follow the steps below.

1. Turn the switch to OFF and unplug the machine.
2. Remove the right side cover (refer to **Removing the Right Side Cover [p. 20]**).
3. Remove the pinch roller (refer to **Removing the Pinch Roller [p. 26]**).
4. Remove the weighted brush cover (refer to **Removing the Weighted Brush Cover [p. 28]**).
5. Remove the tape channel plate (refer to **Removing the Tape Channel Plate [p. 30]**).
6. Remove the idler gear (refer to **Removing the Idler Gear [p. 40]**).
7. Remove the drive gear and clutch assembly (refer to **Removing the Drive Gear with Springs and Clutch Assembly [p. 41]**).
8. Remove the set screw from the feed wheel gear.
9. Remove the feed wheel gear.
10. Remove the bolts from the gearbox/motor mount.
11. Remove the gearbox/motor mount.

The gearbox/motor mount is now removed. At this point, a new gearbox/motor mount may be installed.

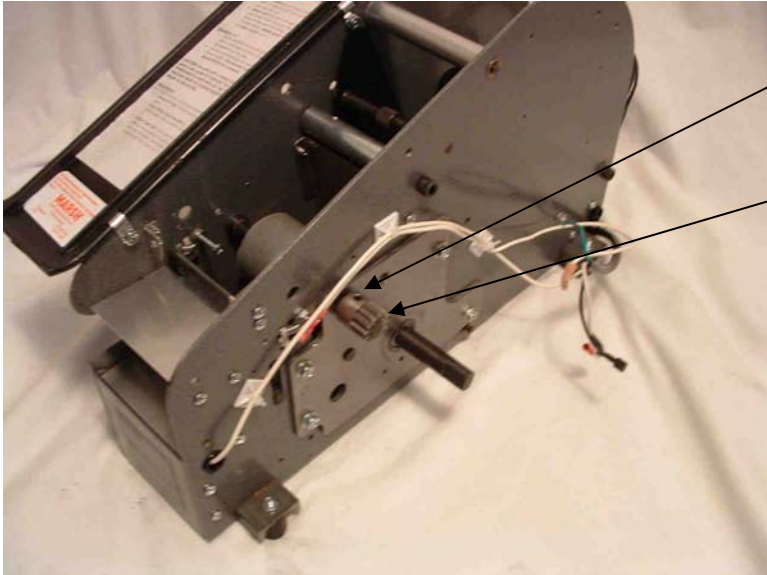
## Attaching the Gearbox/Motor Mount

To attach the gearbox/motor mount, see Fig 22 and follow the steps below.

1. Align the gearbox/motor mount to the chassis using the pins in the gearbox/motor mount.
2. Attach the bolts to the gearbox/motor mount.
3. Slide the feed wheel gear onto the feed wheel shaft.
4. Attach the feed wheel gear to the feed wheel shaft using the set screw.
5. Attach the drive gear and clutch assembly (refer to **Attaching the Drive Gear with Springs and Clutch Assembly [p. 41]**).
6. Attach the idler gear (refer to **Attaching the Idler Gear [p. 40]**).
7. Attach the tape channel plate (refer to **Attaching the Tape Channel Plate [p. 30]**).
8. Attach the weighted brush cover (refer to **Attaching the Weighted Brush Cover [p. 28]**).
9. Attach the pinch roller (refer to **Attaching the Pinch Roller [p. 26]**).
10. Attach the right side cover (refer to **Attaching the Right Side Cover [p. 20]**).

The machine is now ready to continue normal operation.

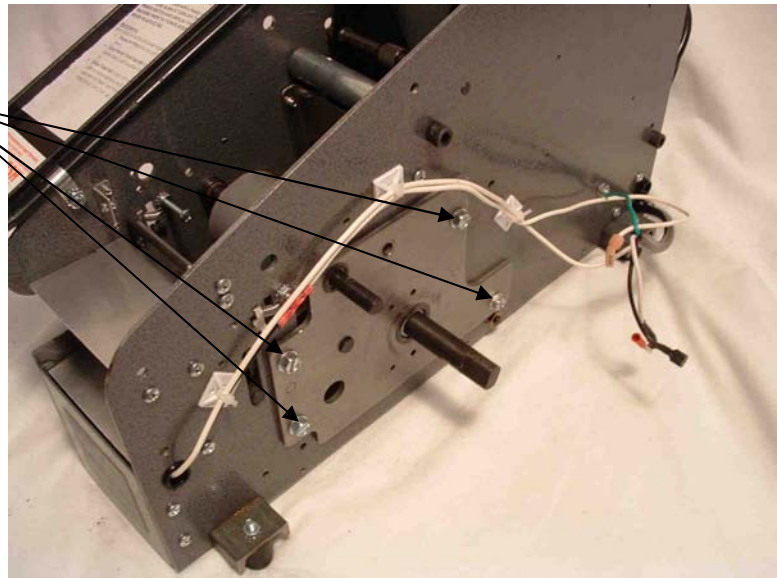
**Fig 22 Gearbox/Motor Mount**



8. Remove the set screw from the feed wheel gear.

9. Remove the feed wheel gear.

10. Remove the bolts from the gearbox/motor mount.



## Replacing the Movable Cutter Blade

To replace the movable cutter blade, see Fig 23 and follow the steps below.

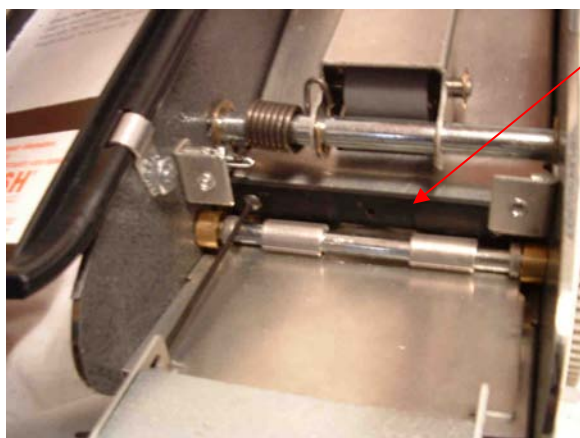
1. Turn the switch to OFF and unplug the machine.
2. Remove the cutter guard.
3. Remove the right side cover (refer to **Removing the Right Side Cover [p. 20]**).
4. Remove the cutter guard clips.
5. Release the tension from the blade by loosening the set screw.
6. With one hand pushing down on the handle, remove the two remaining screws and lift the moveable cutter blade out of the machine.

*NOTE: Place a pencil or screw driver or some other object beneath the cutter blade so that the cutter blade doesn't fall into the machine.*

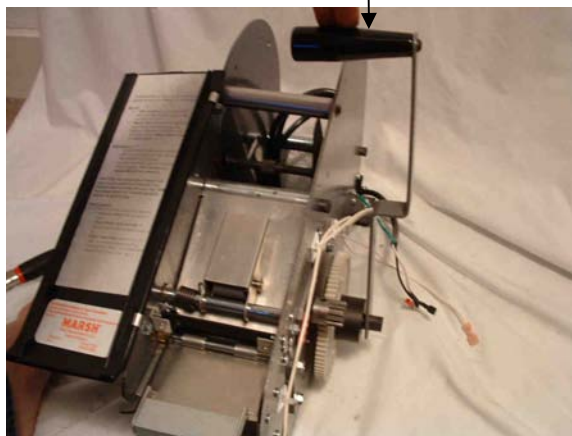
7. With one hand holding the new moveable cutter blade, place the new movable cutter blade so that the two outside screw holes line up and screw the movable cutter blade into place.
8. Tighten the set screw so that there is a slight bend in the movable cutter blade.
9. Reattach the cutter guard clips.
10. Replace the right side cover (refer to **Reattaching the Right Side Cover [p. 20]**).
- 11.
12. Attach the cutter guard.

The machine is now ready to continue normal operation.

**Fig 23 Moveable Cutter Blade**



4. With one hand pushing down on the handle, remove the two remaining screws and lift the moveable cutter blade out of the machine.



## Replacing the Brush

To replace the brush, see Fig 25 and follow the steps below.

1. Turn OFF the machine.
2. Let the machine cool for at least 2 minutes.
3. Remove the water bottle.
4. Remove the water tank
5. Remove the brush from the water tank
6. Place the new brush in the tank so that the bristles of the brush lay somewhat level with respect to the ground.
7. Place the water tank and brush into the water tank holder.
8. Place the water bottle onto the water bottle brackets with the post of the water tank into the duckbill valve.

The machine is now ready to continue normal operation.

## Replacing the Thermostat Assembly

To replace the thermostat assembly, see Fig 26 and follow the steps below.

1. Turn the switch to OFF and unplug the machine.
2. Remove the right side cover (refer to **Removing the Right Side Cover [p. 20]**).
3. Remove the left side cover (refer to **Removing the Left Side Cover [p. 22]**).
4. Remove the water tank holder (refer to **Removing the Water Tank Holder [p. 34]**).
5. With one hand holding a screw driver inside the water tank holder, remove the nuts holding on the thermostat.
6. Attach the new thermostat.

*NOTE: The thermostat must have good surface contact.*

7. Attach the water tank holder (refer to **Attaching the Water Tank Holder [p. 34]**).
8. Attach the left side cover (refer to **Attaching the Left Side Cover [p. 22]**).
9. Attach the right side cover (refer to **Attaching the Right Side Cover [p. 20]**).

The machine is now ready to continue normal operation.

**Fig 25 Brush**

6. Place the new brush in the tank so that the bristles of the brush lay somewhat level with respect to the ground.



**NOT PERPENDICULAR  
TO THE GROUND**

**Fig 26 Thermostat Assembly**

5. With one hand holding a screw driver inside the water tank holder, remove the nuts holding on the thermostat.



## Replacing the Front Cover on Machines S/N 216586 and 402936 and Older

To replace the front cover, see Fig 27 and follow the steps below.

1. Turn the switch to OFF and unplug the machine.
2. Remove the right side cover (refer to **Removing the Right Side Cover [p. 20]**).
3. Remove the left side cover (refer to **Removing the Left Side Cover [p. 22]**).
4. Loosen the screws of the following parts: the coder bar, the dead roller, the brush tank holder, and the weighted brush cover shaft.
5. Remove the four screws from the front cover.
6. Remove the front cover.
7. With one hand pushing the chassis slightly apart, position the new front cover.
8. Attach the screws to the front cover.
9. Tighten the screws of the following parts: in the coder bar, the dead roller, the brush tank holder, and the weighted brush cover shaft.
10. Attach the left side cover (refer to **Attaching the Left Side Cover [p. 22]**).
11. Attach the right side cover (refer to **Attaching the Right Side Cover [p. 20]**).

The machine is now ready to continue normal operation.

## Replacing the Front Cover on Machines S/N 216587 and 402937 and Newer

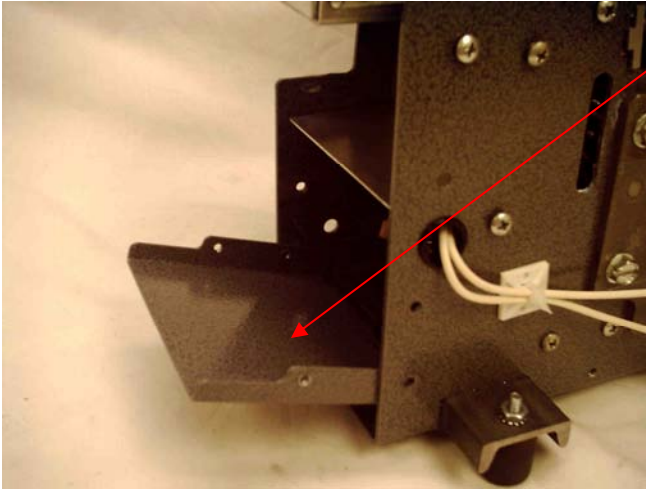
To replace the front cover, simply remove the four screws on the front.

## Replacing the Top Roller

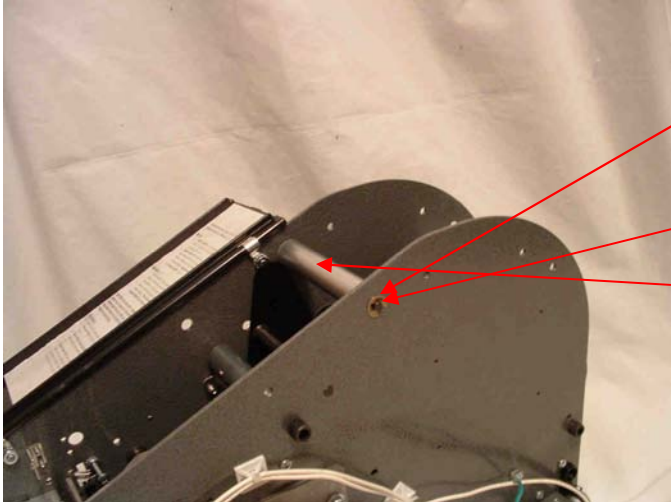
To replace the top roller, see Fig 28 and follow the steps below.

1. Turn the switch to OFF and unplug the machine.
2. Remove the right side cover (refer to **Removing the Right Side Cover [p. 20]**).
3. Remove the e-clips from the top roller shaft.
4. Remove the top roller shaft.
5. Remove the top roller tube.
6. Place the new top roller into the middle of the chassis and hold.
7. Insert the new top roller shaft into the chassis and into the top roller and through the other side of the chassis.
8. Attach the e-clips to each side of the slide roller shaft.
9. Attach the right side cover (refer to **Attaching the Right Side Cover [p. 20]**).

The machine is now ready to continue normal operation.

**Fig 27 Front Cover**

7. With one hand pushing the chassis slightly apart, position the new front cover.

**Fig 28 Top Roller**

3. Remove the e-clips from the slide roller shaft.

4. Remove the top roller shaft.

5. Remove the top roller tube.

## Replacing the Free Spin Roller Assembly

To replace the free spin roller assembly, see Fig 29 and follow the steps below.

1. Turn the switch to OFF and unplug the machine.
2. Remove the right side cover (refer to **Removing the Right Side Cover [p. 20]**).
3. Remove the left side cover (refer to **Removing the Left Side Cover [p. 22]**).
4. Remove the e-clips from the free spin roller shaft.
5. Remove the free spin roller shaft.
6. Remove the free spin roller tube.
7. Place the new free spin roller tube into the middle of the chassis and hold.
8. Insert the new free spin roller shaft into the chassis and the free spin roller tube and through the other side of the chassis.
9. Attach the e-clips to each side of the free spin roller shaft.
10. Attach the left side cover (refer to **Attaching the Left Side Cover [p. 22]**).
11. Attach the right side cover (refer to **Attaching the Right Side Cover [p. 20]**).

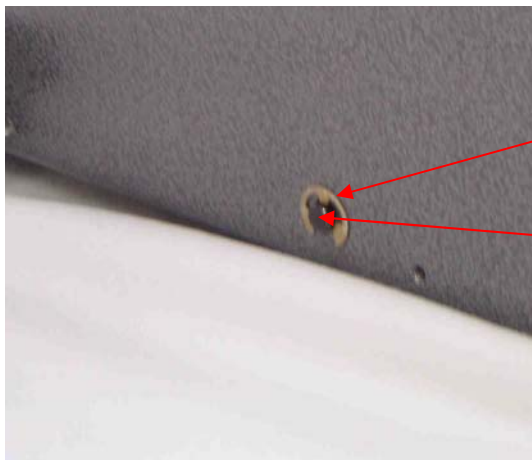
The machine is now ready to continue normal operation.

## Replacing the Ramp

To replace the ramp, see Fig 30 and follow the steps below.

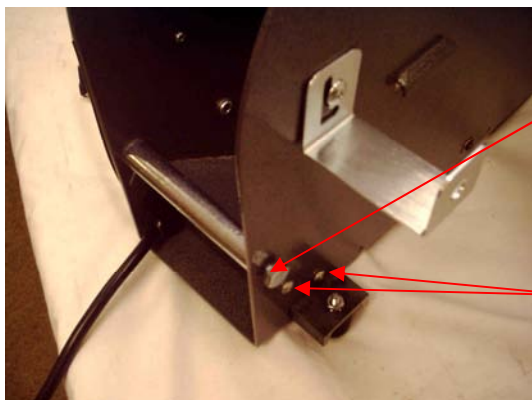
1. Turn the switch to OFF and unplug the machine.
2. Remove the right side cover (refer to **Removing the Right Side Cover [p. 20]**).
3. Remove the left side cover (refer to **Removing the Left Side Cover [p. 22]**).
4. Loosen the screws of the following parts: the dead roller, and the weighted brush cover shaft.
5. Remove the four screws holding the ramp in and remove the ramp.
6. Attach the four screws to the new ramp inside the machine so that the thicker end of the ramp is toward the rear of the machine.
7. Tighten the screws of the following parts: the dead roller, and the weighted brush cover shaft.
8. Attach the left side cover (refer to **Attaching the Left Side Cover [p. 22]**).
9. Attach the right side cover (refer to **Attaching the Right Side Cover [p. 20]**).

The machine is now ready to continue normal operation.

**Fig 29 Free Spin Roller Assembly**

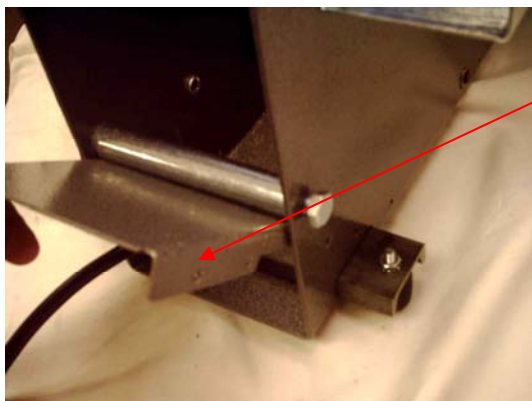
4. Remove the e-clips from the free spin roller shaft.

5. Remove the free spin roller shaft.

**Fig 30 Ramp**

4. Loosen the screws of the following parts: the dead roller, and the weighted brush cover shaft.

5. Remove the four screws holding the ramp in and remove the ramp.



6. Attach the four screws to the new ramp inside the machine so that the thicker end of the ramp is toward the rear of the machine.

## Replacing the Tape Guide Assembly

To replace the tape guide assembly, see Fig 31 and follow the steps below.

1. Turn the switch to OFF and unplug the machine.
2. Remove the right side cover (refer to **Removing the Right Side Cover [p. 20]**).
3. Remove the left side cover (refer to **Removing the Left Side Cover [p. 22]**).
4. Remove the pressure plate.
5. Loosen the screws of the following parts: the coder bar, the dead roller, the tape basket/motor cover, the tape channel plate, and the weighted brush cover shaft.
6. With the tape guides set towards the middle of the machine and one hand spreading the chassis apart, pull the turnbuckle to one side of the machine, twist the turnbuckle slightly and pull the assembly out the rear of the machine.
7. With the new tape guides set towards the middle of the machine and slightly twisted, and one hand spreading the chassis apart, put both ends of the turnbuckle into the chassis.
8. Tighten the screws of the following parts: the coder bar, the dead roller, the tape basket/motor cover, the tape channel plate, and the weighted brush cover shaft.
9. Attach the left side cover (refer to **Attaching the Left Side Cover [p. 22]**).
10. Attach the right side cover (refer to **Attaching the Right Side Cover [p. 20]**).

The machine is now ready to continue normal operation.

## Replacing the Fixed Blade

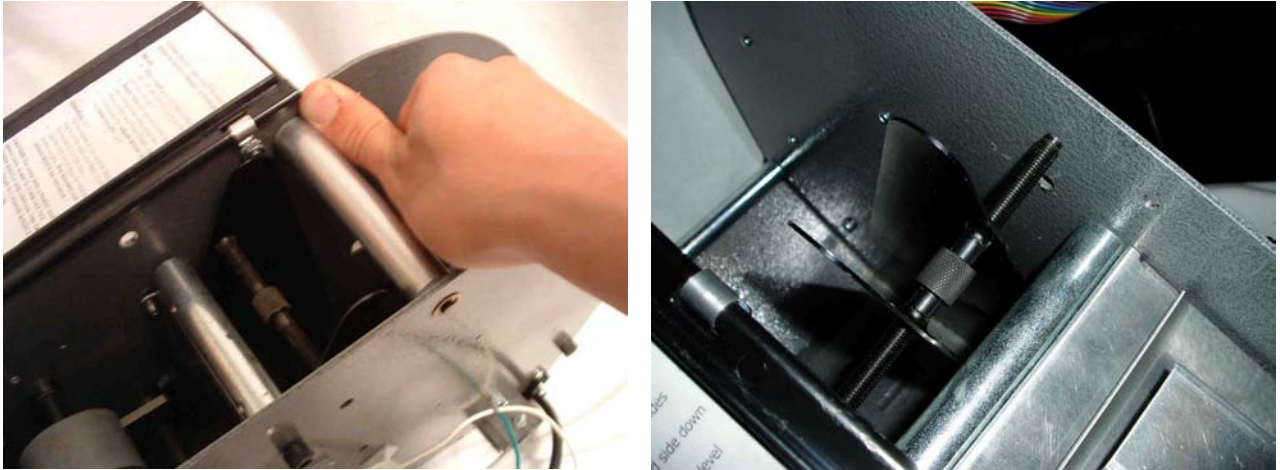
To replace the fixed blade, see Fig 32 and follow the steps below.

1. Turn the switch to OFF and unplug the machine.
2. Loosen the screw retaining the fixed blade stop and remove the stop.
3. Remove the fixed blade retaining screw.
4. Push the fixed blade shoe toward the rear of the machine.
5. Use a magnet to pull fixed blade from the machine.
6. Insert the new fixed blade into the chassis. The blade should be resting on both sides of the chassis.

*CAUTION: Do not drop any components into the machine.*

7. Release the fixed blade shoe.
8. Reinstall the fixed blade retaining screw.
9. Reinstall the fixed blade stop and tighten the retaining screw.

The machine is now ready to continue normal operation.

**Fig 31 Tape Guide Assembly**

6. With the tape guides set towards the middle of the machine and one hand spreading the chassis apart, pull the turnbuckle to one side of the machine, twist the turnbuckle slightly and pull the assembly out the rear of the machine.

**Fig 32 Fixed Blade**

3. Push the fixed blade shoe toward the rear of the machine.



4. Use a magnet to pull fixed blade from the machine.

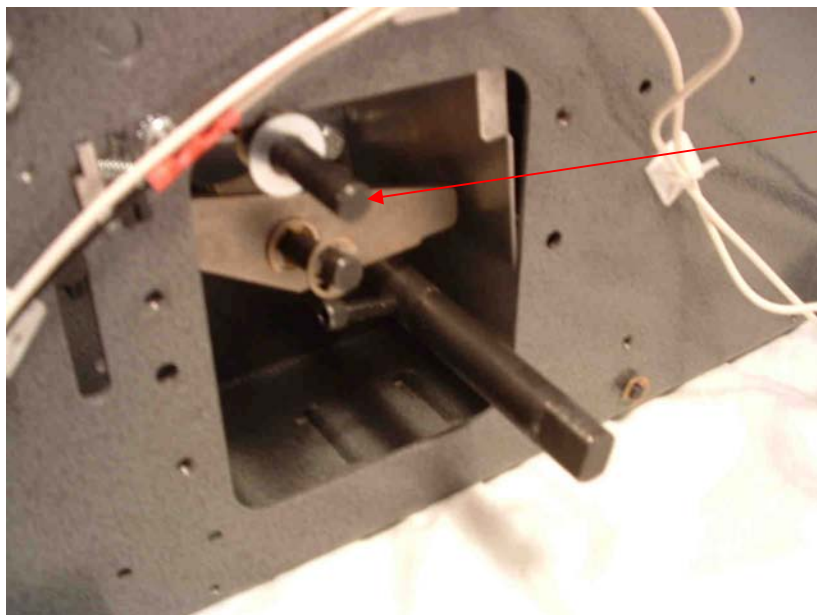
## Replacing the Feed Wheel

To replace the feed wheel, see Fig 33 and follow the steps below.

1. Turn the switch to OFF and unplug the machine.
2. Remove the right side cover (refer to **Removing the Right Side Cover [p. 20]**).
3. Remove the pinch roller (refer to **Removing the Pinch Roller [p. 26]**).
4. Remove the weighted brush cover (refer to **Removing the Weighted Brush Cover [p. 28]**).
5. Remove the tape channel plate (refer to **Removing the Tape Channel Plate [p. 30]**).
6. Remove the idler gear (refer to **Removing the Idler Gear [p. 40]**).
7. Remove the drive gear with springs and clutch assembly (refer to **Removing the Drive Gear with Springs and Clutch Assembly [p. 41]**).
8. Remove the gearbox/motor mount (refer to **Removing the Gearbox/Motor Mount [p. 43]**).
9. Remove the feed wheel shaft and the feed wheel from the chassis at a downward angle.
10. Attach the e-clip and the washer to the new feed wheel shaft.
11. Insert the new feed wheel shaft and feed wheel into the chassis into the bearing.
12. Attach the gearbox/motor mount (refer to **Attaching the Gearbox/Motor Mount [p. 43]**).
13. Attach the drive gear and clutch assembly (refer to **Attaching the Drive Gear with Springs and Clutch Assembly [p. 41]**).
14. Attach the idler gear (refer to **Attaching the Idler Gear [p. 40]**).
15. Attach the tape channel plate (refer to **Attaching the Tape Channel Plate [p. 30]**).
16. Attach the weighted brush cover (refer to **Attaching the Weighted Brush Cover [p. 28]**).
17. Attach the pinch roller (refer to **Attaching the Pinch Roller [p. 26]**).
18. Attach the right side cover (refer to **Attaching the Right Side Cover [p. 20]**).

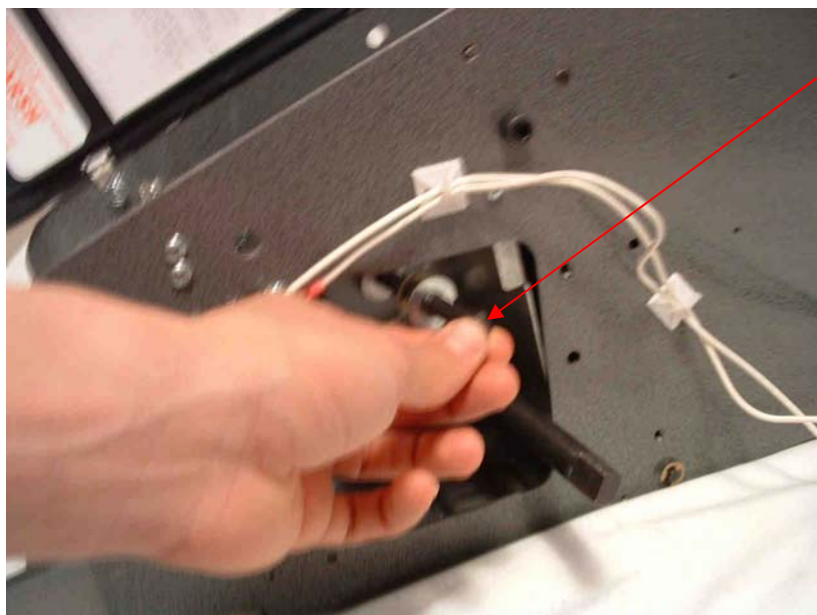
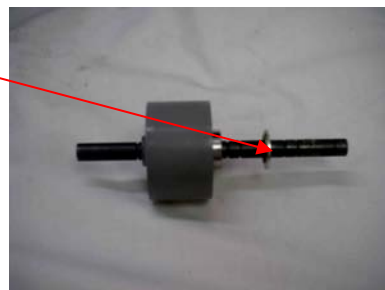
The machine is now ready to continue normal operation.

**Fig 33 Feed Wheel**



9. Remove the feed wheel shaft and the feed wheel from the chassis at a downward angle.

10. Attach the e-clip and the washer to the new feed wheel shaft



11. Insert the new feed wheel shaft and feed wheel into the chassis into the bearing.



## Replacing the Handle Shaft

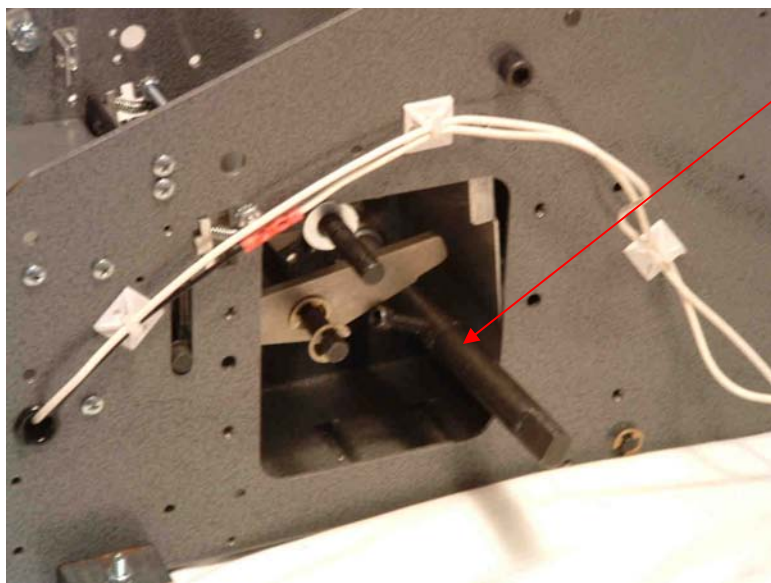
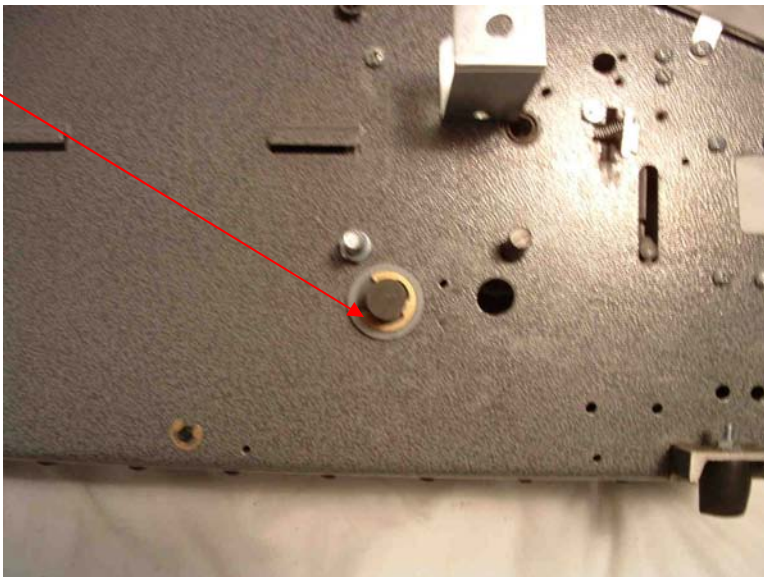
To replace the handle shaft, see Fig 34 and follow the steps below.

1. Turn the switch to OFF and unplug the machine.
2. Remove the right side cover (refer to **Removing the Right Side Cover [p. 20]**).
3. Remove the left side cover (refer to **Removing the Left Side Cover [p. 22]**).
4. Remove the pinch roller (refer to **Removing the Pinch Roller [p. 26]**).
5. Remove the weighted brush cover (refer to **Removing the Weighted Brush Cover [p. 28]**).
6. Remove the tape channel plate (refer to **Removing the Tape Channel Plate [p. 30]**).
7. Remove the idler gear (refer to **Removing the Idler Gear [p. 40]**).
8. Remove the drive gear and clutch assembly (refer to **Removing the Drive Gear with Springs and Clutch Assembly [p. 41]**).
9. Remove the cutter return spring (refer to **Removing the Cutter Return Spring [p. 24]**).
10. Remove the gearbox/motor mount (refer to **Removing the Gearbox/Motor Mount [p. 43]**).
11. Remove the large e-clip from the left side of the handle shaft.
12. Remove the handle shaft from the chassis.
13. Insert a new handle shaft into the ½" bearing.
14. Attach the large e-clip to the left side of the handle shaft.
15. Attach the gearbox/motor mount (refer to **Attaching the Gearbox/Motor Mount [p. 43]**).
16. Attach the cutter return spring, making sure that the screw heads on the handle shaft are toward the front of the machine while the head of the cutter slide bolt is toward the bottom of the chassis (refer to **Attaching the Cutter Return Spring [p. 24]**).
17. Attach the drive gear and clutch assembly (refer to **Attaching the Drive Gear with Springs and Clutch Assembly [p. 41]**).
18. Attach the idler gear (refer to **Attaching the Idler Gear [p. 40]**).
19. Attach the tape channel plate (refer to **Attaching the Tape Channel Plate [p. 30]**).
20. Attach the weighted brush cover (refer to **Attaching the Weighted Brush Cover [p. 28]**).
21. Attach the pinch roller (refer to **Attaching the Pinch Roller [p. 26]**).
22. Attach the right side cover (refer to **Attaching the Right Side Cover [p. 20]**).

The machine is now ready to continue normal operation.

**Fig 34 Handle Shaft**

11. Remove the large e-clip from the left side of the handle shaft.



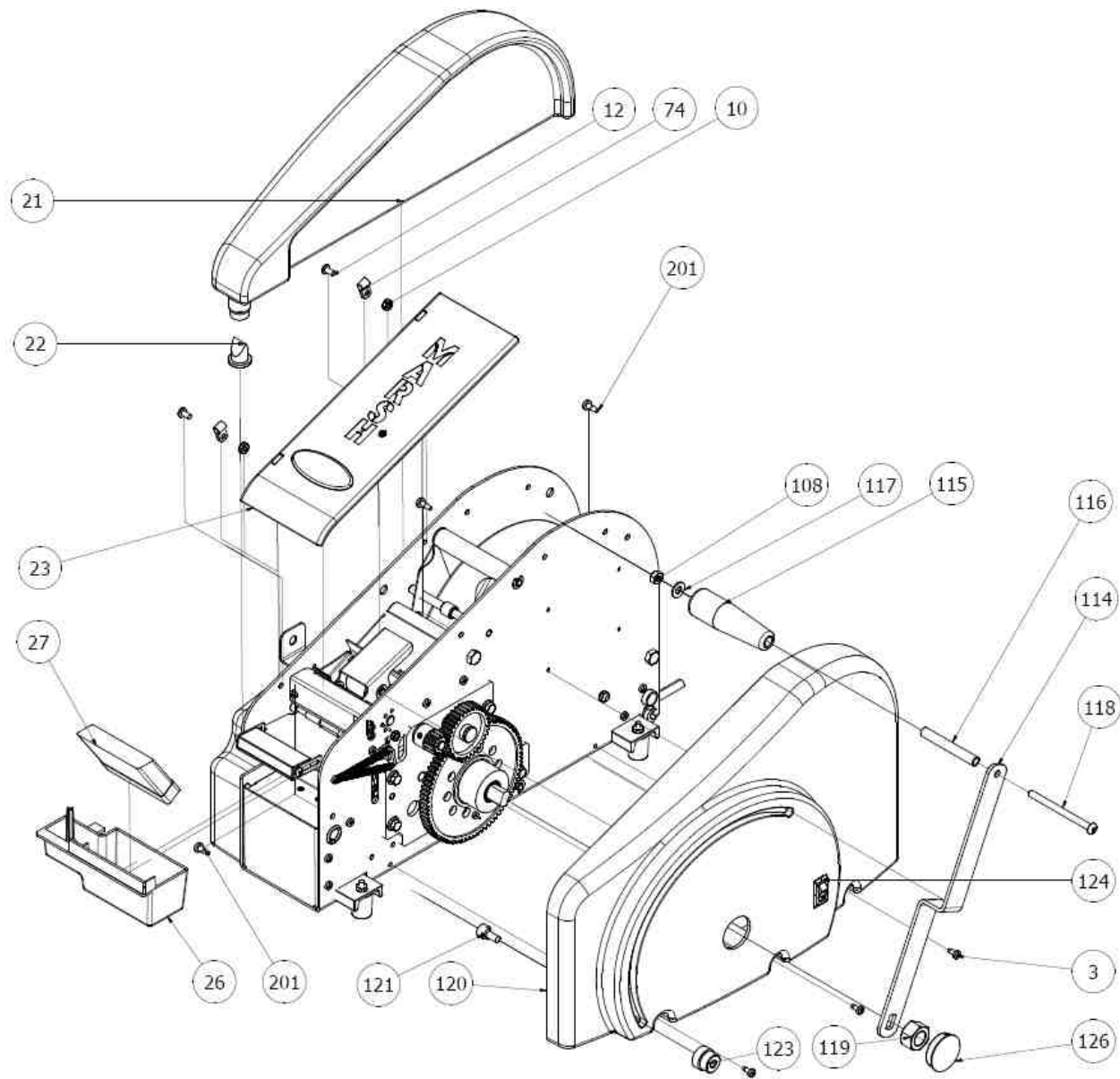
12. Remove the handle shaft from the chassis.

## Parts Lists

Replacement Part Table for TD2100 Manual Drawing #1

Replacement Part Number	Description	Item Number	Item Description	Quantity
RP40310	Top Cover Assembly	23	Top Cover	1
		NS	Logo	1
		10	Nut	2
		74	Hinge	2
		12	Screw	2
RP40311	Top Cover Hinge with Screw	74	Hinge	2
		10	Nut	2
		12	Screw	2
RP40401	Water Bottle with Valve	21	Bottle	1
		22	Duckbill Valve	1
RP40405	Brush Tank	26	Tank	1
RP40407	Moistening Brush	27	Brush	1
RP41301	Right Side Cover Assembly	120	Side Cover	1
		3	Screw	3
		202	Screw	2
		201	Screw	1
		126	Hole Plug	1
RP41301 H	Right Side Cover Assembly w/ Heater	123	Stop Assy	1
		120	Side Cover	1
		3	Screw	3
		202	Screw	2
		201	Screw	1
		124	Switch	1
RP150536	Power Switch	124	Switch	1
RP41257	Handle	126	Hole Plug	1
		114	Handle Arm	1
		115	Handle	1
		116	Handle Insert	1
		117	Washer	1
		118	Screw	1
RP43102	Handle Hole Plug	119	Nut	1
RP41260	Inch Measuring Strip	126	Hole Plug	1
RP41262	Metric Measuring Strip	NS	Strip	1
RP41290	Stop Bolt	123	Nut	1
		121	Screw	1

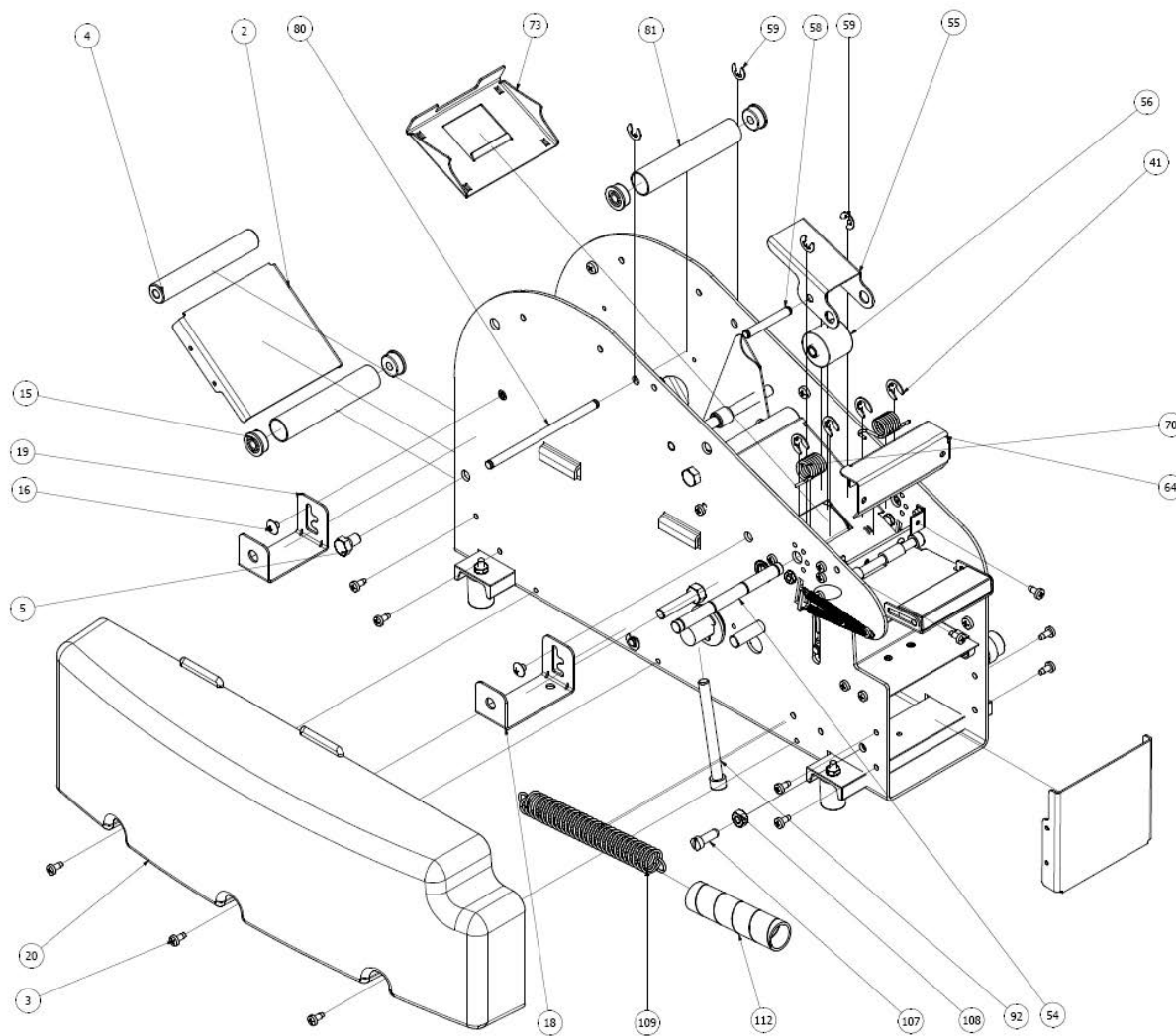
TD2100 Manual Drawing #1



Replacement Part Table for TD2100 Manual Drawing #2

Replacement Part Number	Description	Item Number	Item Description	Quantity
RP40315	Ramp	2	Cover	1
		3	Screw	4
RP40505	Pressure Plate	73	Plate	1
RP40522	Top and Free Roller Assembly	81	Roller	1
		80	Shaft	1
		59	E-Clip	2
RP40305	Left Side Cover	20	Side Cover	1
		3	Screw	3
RP40404	Rear Water Bottle Bracket with Screw	19	Bracket	1
		16	Screw	1
RP40403	Front Water Bottle Bracket with Screw	18	Bracket	1
		16	Screw	1
RP40325	Cutter Guard with Screws	64	Guard	1
		3	Screw	2
RP40540	Pinch Roll Assembly	58	Pin	1
		70	Spring	2
		59	E-Clip	2
		54	Shaft	1
		55	Holder	1
		56	Roll	1
		41	E-Clip	4
RP40530	Pinch Roll Only	56	Pinch Roll	1
RP41905	Cutter Return Spring Assembly	109	Spring	1
		112	Damper	1
		107	Screw	1
		108	Nut	2
		NS	S-Hook	1
RP41904	Cutter Slide Bolt	92	Screw	1
RP40825	Fixed Blade Stop	NS	Fixed Blade Stop	1

### TD2100 Manual Drawing #2



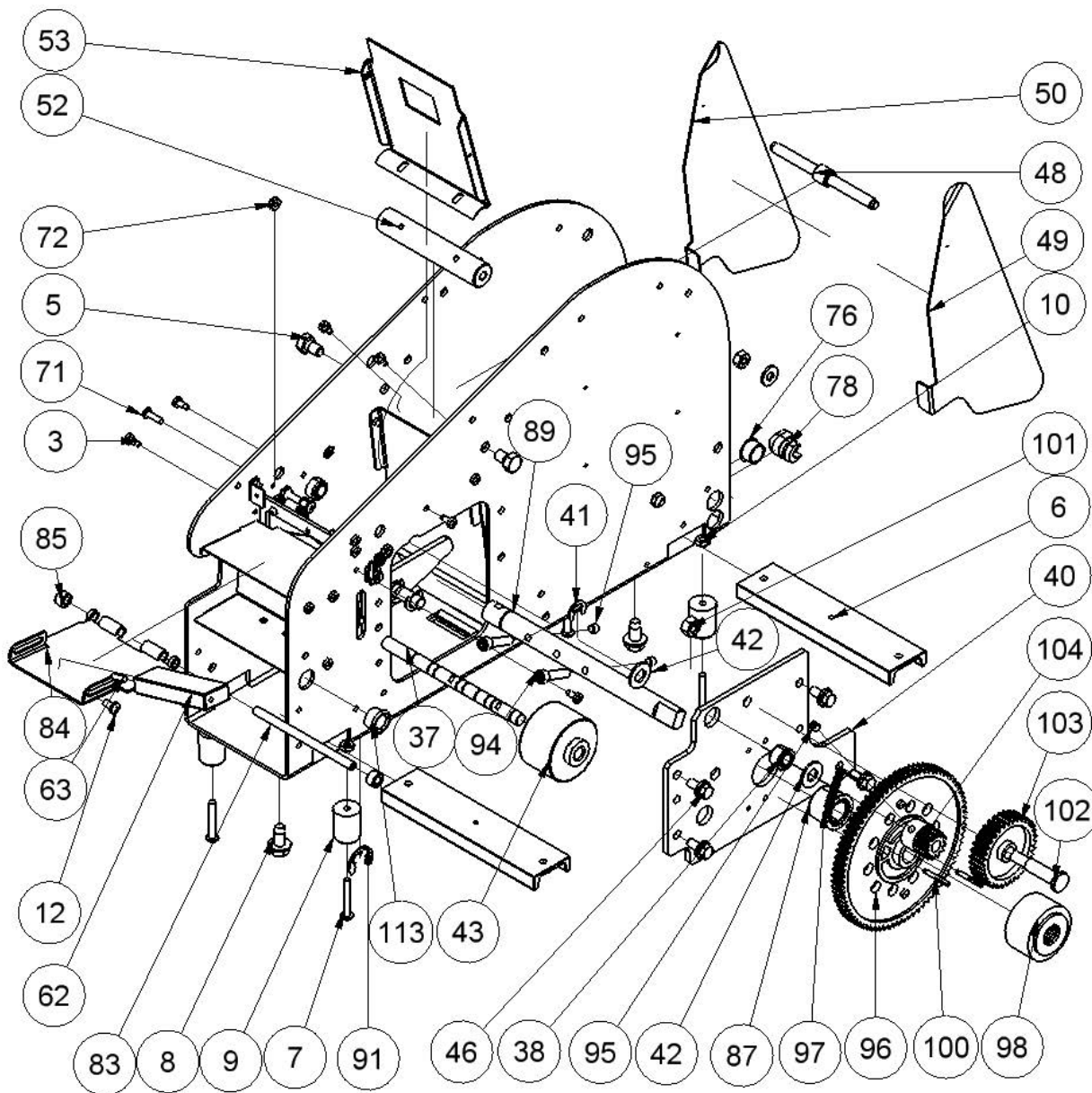
## Replacement Part Table for TD2100 Manual Drawing #3

Replacement Part Number	Description	Item Number	Item Description	Quantity
RP40110	Foot Channel	6	Bar	1
		8	Screw	1
RP40115	Rubber Foot	9	Rubber Foot	1
		7	Screw	1
		10	Nut	1
RP40515	Tape Channel Plate	53	Plate	1
		3	Screw	2
RP40550	Tape Guide Assembly	48	Turnbuckle	1
		49	Guide RHS	1
		50	Guide LHS	1
RP42956	90° Strain Relief	78	Power Cord Relief	1
RP42957	Dome Plug	76	Plug	1
RP42958	Split Bushing	113	Split Bushing	1
RP40235	Urethane Feed Wheel w/ Shaft	43	Wheel	1
RP41101	Gearbox/Motor Mount Frame	40	Gearbox/Motor Frame	1
RP5065X	Drive Gear with Springs	96	Drive Gear	1
		97	Spring	2
RP5063X	Clutch Roller Assembly	98	Clutch	1
		100	Pin	2
RP40516	Brush Tank Cover with Rod and Bushing	84	Weighted Tank Cover	1
		3	Screw	2
		85	Brass Bushing	2
		83	Rod	1
RP40517	Tape Weight with Screw	62	Weighted Tank Cover	1
		12	Screw	1
		63	Pin	1
RP40231	3/8 Bearing	38	Bearing	1
RP41221	1/2 Bearing	87	Bearing	1
RP40560	Dead Roller	52	Roll	1
		5	Screw	1

Replacement Part Table for TD2100 Manual Drawing #3 ctd

Replacement Part Number	Description	Item Number	Item Description	Quantity
RP41220	Handle Shaft Assembly	89	Shaft	1
		9	Screw	2
		94	Screw	2
		91	E-Clip	1
RP16172	Washer	42	Washer	1

TD2100 Manual Drawing #3





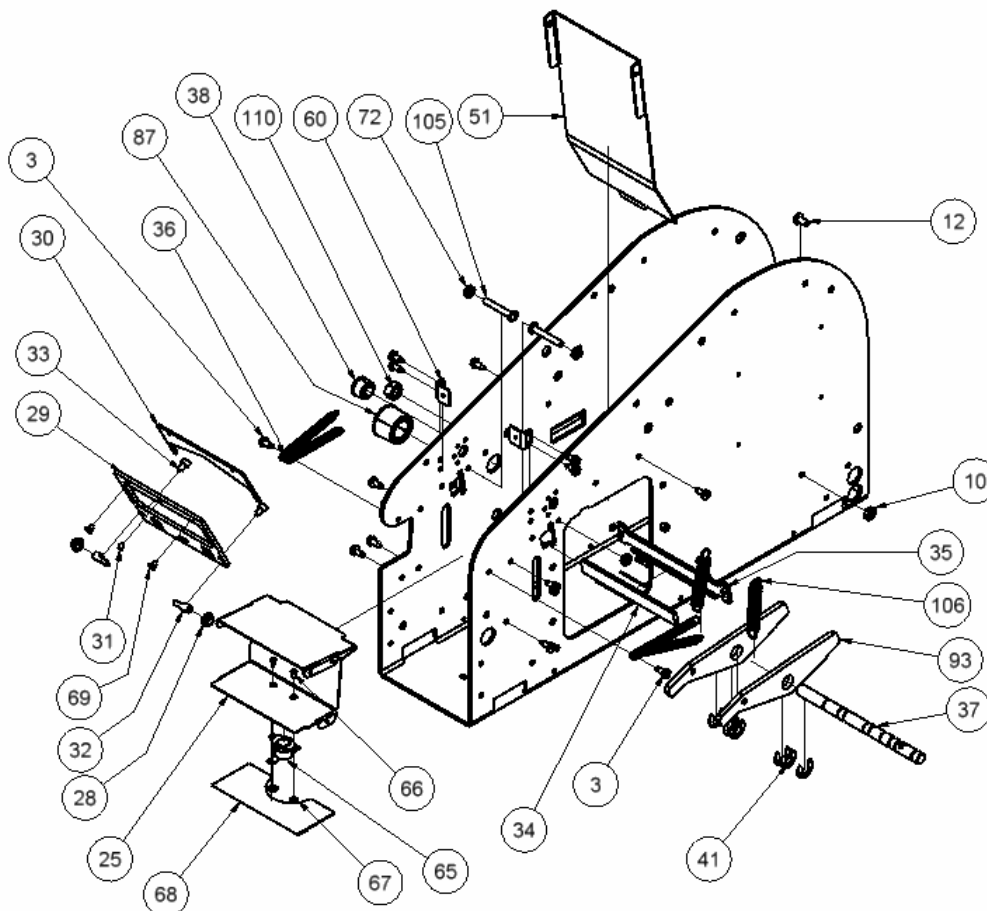
## Replacement Part Table for TD2100 Manual Drawing #4

Replacement Part Number	Description	Item Number	Item Description	Quantity
RP40320	Tape Basket/Motor Cover	51	Steel Plate	1
		3	Screw	2
RP41258	Cutter Actuating Arm Assembly	93	Arm	2
		106	Spring	2
		41	E-Clip	6
		37	Shaft	1
		105	Screw	2
		72	Nut	2
RP40703	Cutter Replacement Kit	29	Cutter Blade Holder	1
		30	Cutter Blade-Movable	1
		34	Fixed Blade	1
		36	Springs	4
		35	Fixed Blade Shoe	1
		31	Set Screw	1
		69	Screw	2
		33	Screw	2
		32	Bushing	2
		28	Cutter Guide	2
RP40710	Cutter Blade-Movable	30	Cutter Blade-Movable	1
		69	Screw	2
		31	Set Screw	1
RP40715	Cutter Blade-Fixed	34	Fixed Blade	1
		36	Spring	4
		35	Fixed Blade Shoe	1
		3	Screw	2
RP40740	Cutter Spring-Fixed Blade	36	Spring	4
RP42978	Heater/Thermostat Assembly 110V	25	Water Tank Holder	1
		65	Thermostat 110V	1
		66	Screw	2
		67	Nut	2
		68	Heater 110V	1
		3	Screw	7
		NS	Wire	
NS	Wire Connections			
RP43977	Thermostat Assembly 110V	65	Thermostat 110V	1
		66	Screw	2
		67	Nut	2
		NS	Wire	
		NS	Wire Connections	

Replacement Part Table for TD2100 Manual Drawing #4 ctd.

Replacement Part Number	Description	Item Number	Item Description	Quantity
RP40231	3/8 Bearing	38	Bearing	1
RP41221	1/2 Bearing	87	Bearing	1
RP42810	Heater/Thermostat Assembly 220V	25	Water Tank Holder	1
		65	Thermostat 110V	1
		66	Screw	2
		67	Nut	2
		68	Heater 110V	1
		3	Screw	7
		NS	Wire	
		NS	Wire Connections	
		NS	Transformer	1
RP40236	Cutter Guard Clip	60	Clip	1
		3	Screw	2
RP41290	Stop Bolt and Nut	72	Stop Block	1
		105	Screw	1
RP40352	Water Tank Holder	25	Water Tank Holder	1
		3	Screw	7

TD2100 Manual Drawing #4



## Addendum

### Removing the Weighted Brush Cover

To remove the weighted brush cover, follow the steps below.

1. Remove the water bottle.
2. Remove the cutter guard by removing the side screws.
3. Slide the flapper rod from the machine.
4. Remove the screw from the tape weight and remove the tape weight from the weighted brush cover.

The weighted brush cover is now removed from the machine. At this point a new weighted brush cover or tape weight may be installed.

### Attaching the Weighted Brush Cover

To attach the weighted brush cover, follow the steps below.

1. Position the tape weight into the new weighted brush cover and screw in the screw.
2. Slide one end of the flapper rod into to the chassis.
3. Place a bushing, then the weighted brush cover, then another bushing on the flapper rod and slide the rod through the other side of the chassis.
4. Attach the cutter guard.
5. Attach the water bottle.

The machine is now ready to continue normal operations.

Old Version

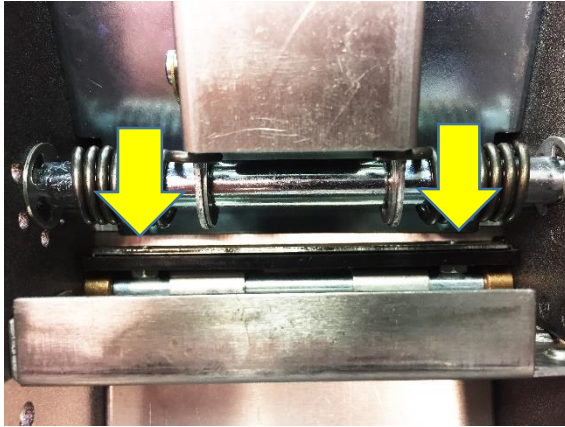


Current Version

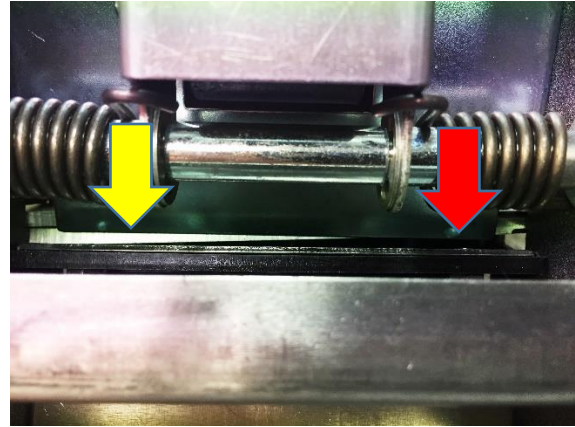


If the machine is not cutting tape when the desired length is selected, the blade may be jammed.

1. First turn the power switch to the off position
2. Open the top cover, lift the pressure wheel, and pull the tape out towards the rear of the machine.
3. Inspect the position of the blade guide.

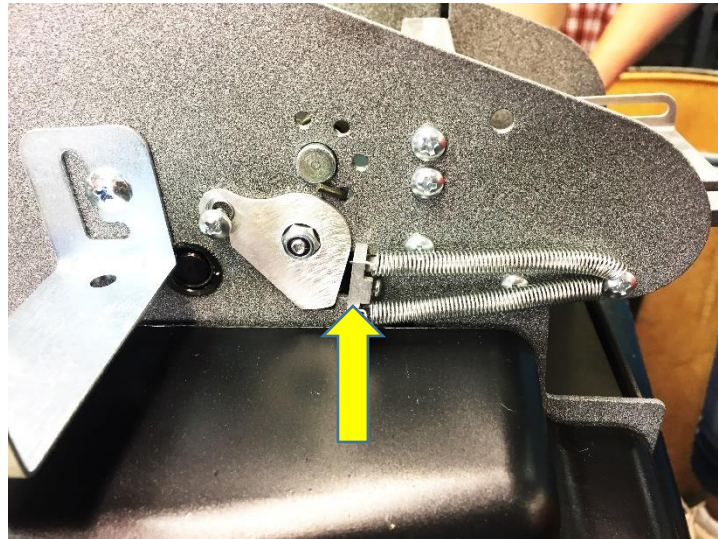


**GOOD**

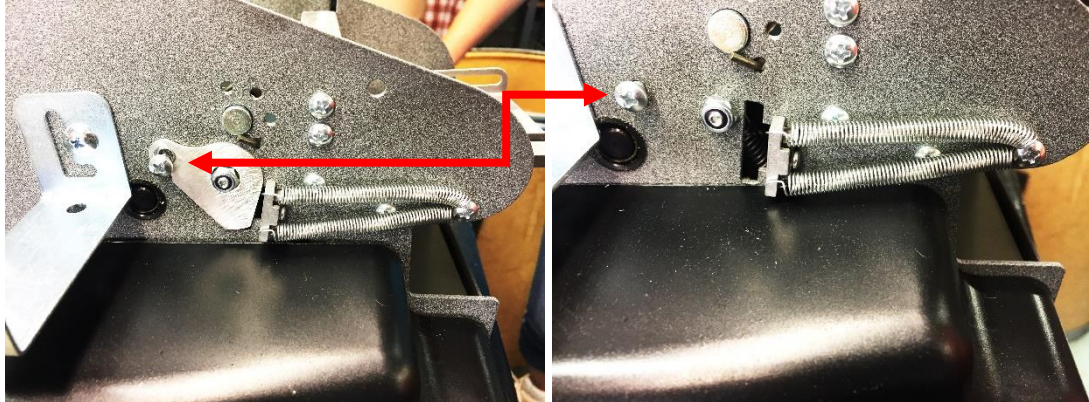


**BAD**

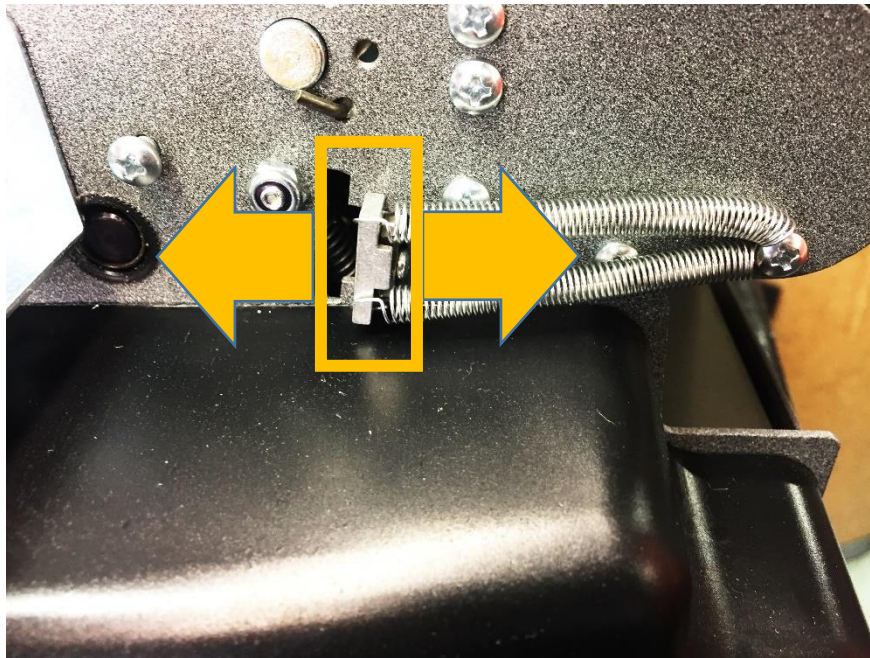
4. If the blade appears as in the bad position follow the procedure below.
  - A) Remove the water bottle from the left hand side of the dispenser.
  - B) Locate the end of the blade guide attached to the springs.



- C) Remove the blade hold down bracket by unscrewing the single mounting screw.



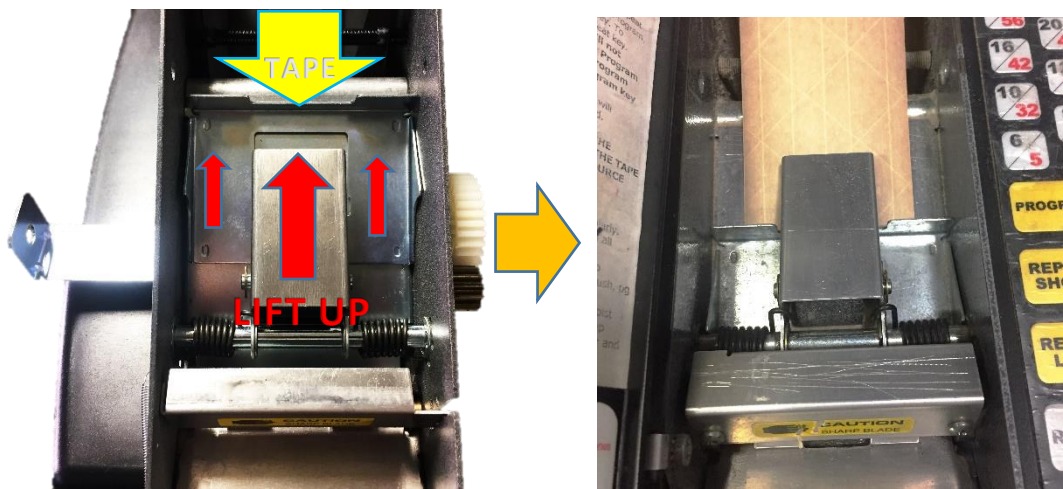
- D) Once the hold down bracket is removed, move the blade guide back and forth until the other side of the blade had been freed from the jammed position.



- E) Re-install the hold down bracket, water bottle, and reload tape.

### Correctly routing tape and pressure plate

1. First turn the power switch to the off position.
2. Open the top cover and place the new roll into the back of the dispenser
3. Pull about 1 foot of tape out from the roll to insert in to the machine.
4. Lift the pressure wheel and plate, and insert the tape under the plate.



- Incorrect installation of pressure plate

